



USER GUIDE

LOGIC AIR MONOBLOC HEAT PUMP SYSTEM

When replacing any part on this appliance, use only spare parts that you can be assured conform to the safety and performance specification that we require. Do not use reconditioned or copy parts that have not been clearly authorised by Ideal Heating.

For the very latest copy of literature for specification and maintenance practices visit our website idealheating.com where you can download the relevant information in PDF format.



CONTENTS

1. Introduction	3
2. Safety	3
3. General Information	4
4. Basic Heat Pump operating Principle.....	4
5. Basic Logic Air Functions	5
6. Basic Logic Air Controller and Display Functions.....	6
7. Logic Air Alarms	9
8. Fault Codes.....	10
9. Troubleshooting.....	11
10. Warranty.....	12

WEEE DIRECTIVE 2012/19/EU
Waste Electrical and Electronic Equipment Directive

- At the end of the product life, dispose of the packaging and product in a corresponding recycle centre.
- Do not dispose of the unit with the usual domestic refuse.
- Do not burn the product.
- Remove the batteries.
- Dispose of the batteries according to the local statutory requirements and not with the usual domestic refuse.



Ideal Heating is a member of the Benchmark scheme and fully supports the aims of the programme. Benchmark has been introduced to improve the standards of installation and commissioning of central heating systems in the UK and to encourage the regular servicing of all central heating systems to ensure safety and efficiency.



THE BENCHMARK SERVICE INTERVAL RECORD MUST BE COMPLETED AFTER EACH SERVICE

1. INTRODUCTION

The Logic Air Heat Pump System consists of the following key components.

- Logic Air Monobloc Air Source Heat Pump (installed external to the property).
- Logic Air Domestic Hot Water Cylinder
- Logic Air Control Box (Supplied separately as a wall mounted option or as part of the Logic Air Pre-Plumbed option).

The Logic Air Monobloc Heat Pump is an Air to Water type system and suitable to be installed in a domestic household within a closed loop heating system. The Logic Air Monobloc Heat Pump does not provide a cooling function. The appliance will produce condensate water, a suitable disposal system and drainage point shall need to be installed.

The Heat Pump takes heat from the ambient outdoor air for transfer into domestic hot water or space heating system. This air is not to be ducted or re utilised and must be allowed to flow freely back into the natural environment.

The Logic Air Domestic Hot Water cylinder is to be used to store heat from the Heat Pump. The DHW cylinder is to be installed within a domestic household.

The Logic Air Control Box provides the overall interface and control of the heating entire system. The control box is to be installed within the property, a limited interface is provided for the end user, however a programmable room thermostat will provide the day to day interface such as space heating temperatures and schedule / timer functions.

2. SAFETY

Flammable Refrigerant:

The Heat Pump is charged with R32 which is a flammable, odourless, and colourless refrigerant. In the event of a leak from the refrigerant circuit this can create a hazardous environment. To reduce the risk of a hazardous event, the installation instructions should be followed, and the installation area should be kept clear of ignition sources, including but not limited to; electrical switches, electrical plug sockets, and lamps.

Modification of the Products and Installation Environment:

The product is not to be modified or tampered with in any way that is not defined and approved by this document. Make sure that the requirements for both the products and installation environments are always followed. The end user should be properly informed of the installation area and product requirements during the handover process.

Improper Maintenance:

The product is to be regularly maintained and serviced by an appropriately qualified service engineer. The end user should be properly informed of maintenance and care requirements during the handover process.

Inappropriate Operation:

The product is to be operated as outlined in both this document and the user manuals. The end user must be properly informed of intended and acceptable operation methods during the handover process.

Electrical Risk:

Work on electrical components must only be carried out by a competent electrician. Electrical supplies must be locked in the off position when any work is done near electrical components. Failure to comply with this requirement can result in severe injury or death. If any of the supply cables are damaged, they must be replaced by the manufacturer, its service agent or similarly qualified persons in order to avoid a hazard.

Correct Disposal of Waste:

Waste from the products, such as cardboard, plastics, and refrigerant must be disposed of appropriately and recycled where applicable. Refrigerant must not be released into the atmosphere.

Presence of Frozen Condensate in Walkways:

There is condensate produced by the Heat Pump which can potentially build up around the heat pump and freeze if not properly disposed of. Appropriate disposal methods of the condensate should be implemented and maintained to prevent slipping hazard.

Electrical Safety

Electrical Supply.

Power Supply – 230 V ~ 50Hz

4 & 5 kW Recommended Circuit Breaker size 16A.

8 & 10 kW Model Recommend Circuit Breaker size 32A.

This appliance is to be earthed.

The system is provided with two separate 230V power supplies; one is for the Logic Air Monobloc Heat Pump and shared with the Logic Air Control Box. The second power supply is intended for the backup up heater.

Ⓢ **IMPORTANT: This appliance must not be operated without all the covers and casing(s) correctly fitted.**

If it is known or suspected that a fault exists on the system, then it MUST NOT BE USED until the fault has been investigated and corrected by a suitably trained and competent person.

Under NO circumstances should any sealed components on this appliance be used incorrectly or tampered with.

This appliance can be used by children 8 years and above. Also, persons with reduced physical, sensory, or mental capabilities, or lack of experience and knowledge, provided they have been given supervision or instruction concerning use of the appliance in a safe way and understand the hazards involved. Children shall not play with the appliance. Cleaning and user maintenance shall not be made by children without supervision.

3. GENERAL INFORMATION

- During periods of Heat Pump operation, notably during defrost cycles, a plume of steam may be visible. This is normal and due to moisture and/or ice formation evaporating.
- During periods of Heat Pump operation, the appliance will produce condensate water, a suitable disposal system and drainage point shall be installed.
- During periods of Heat Pump operation, both the evaporator fan and compressor speed will change, dependent upon the prevailing conditions and heat output level required. Due to this there may be a noticeable change in the appliance noise levels and tone which is normal.
- The area directly around the Heat Pump should be kept clear at all times. Any items that may restrict the airflow to the Heat Pump such as leaves, litter etc. should be removed immediately as these may negatively affect the operational efficiency.
- The area directly around the Logic Air Control Box should be kept clear at all times. Items such as wet laundry should not be placed upon the control box and general clearances illustrated within the Installation Manual must be respected.

CLEANING

⚠ CAUTION: The Heat Pump contains sensitive components that may be damaged by the use of hose pipes or high-pressure washers.

DO NOT use abrasive cleaning materials and harsh solvents / cleaning solutions.

Logic Air Monobloc Heat Pump Casing:

For normal cleaning of the Heat Pump casing use a weak soap spray solution only. Rinse off soap spray solution with a Low-pressure hose or Low-pressure spray bottle only.

Logic Air Control Box:

For normal cleaning simply dust with a dry cloth. For stubborn marks and stains, wipe with a damp cloth and finish with a dry cloth.

Logic Air Domestic Hot Water Cylinder:

For normal cleaning simply dust with a dry cloth. For stubborn marks and stains, wipe with a damp cloth and finish with a dry cloth.

MAINTENANCE

The frequency of servicing will depend upon the installation condition and usage, but it should be carried out at least annually by a competent Heat Pump engineer.

4. BASIC HEAT PUMP OPERATING PRINCIPLE

The Heat Pump contains a sealed and closed loop refrigerant circuit which contains a mildly flammable refrigerant R-32. When operating, refrigerant is continuously circulated by a compressor where it absorbs heat from the outdoor air which is passed through a heat exchanger and transferring that heat to water which is used in heating and hot water systems.

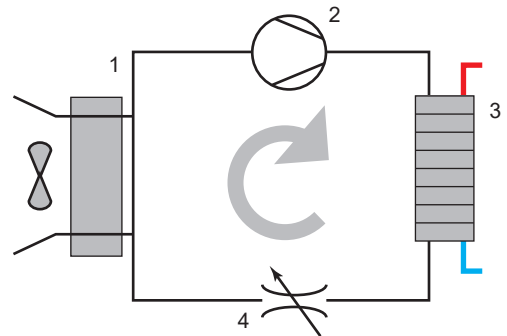

The circuit consists of four main components/functions.

1. Evaporator Heat Exchanger - Refrigerant absorbs heat energy from the outdoor ambient air.
2. Compressor – Refrigerant is compressed and circulated around the closed loop circuit.
3. Condenser Heat Exchanger – Refrigerant transfers heat energy to the heating or hot water systems.
4. Expansion Device – Refrigerant pressure and temperature is transformed.

5. BASIC LOGIC AIR FUNCTIONS

Domestic Hot Water:

If there is a domestic hot water (DHW) Cylinder installed and the temperature of the DHW Cylinder is less than the Hot Water setpoint, the primary heat pump circuit is activated and directed (via the diverter valve) to heat the hot DHW Cylinder.

The Heat Pump will operate until the DHW Cylinder has reached its setpoint. This function will always take priority over the space heating system within the programmed time.

Note: Domestic Hot Water Heating and Space Heating functions cannot operate simultaneously

Space Heating:

If there is a heating demand and the temperature of any thermostat is less than its setpoint, the primary circuit is activated and directed (via the diverter valve) to heat the space heating circuits. The Heat Pump and primary heating circuit circulator will be active until the space heating has reached its setpoint.

Note: Domestic Hot Water Heating and Space Heating functions cannot operate simultaneously

Anti-Legionella:

If there is a DHW cylinder installed, Anti-Legionella measures should be utilised in accordance with HSE guidance HSG274 Part 2. The control system is provided with an Anti-Legionella function for the DHW cylinder, the default parameter, which is adjustable according to the installation and user requirements, initiates this function once per week and heats the DHW cylinder to 60°C for a period of 1 hour.

Logic Air Monobloc ASHP Defrost Method:

During operation, the Heat Pump will periodically be required to go through an automatic defrosting process dependant on the outdoor air temperature and humidity levels. Over time the evaporator will begin to collect water which will then frost. The defrost process causes the accumulated frost to thaw and change to liquid. This liquid water then collects in the base panel and flows through into the condensate drain openings located on the base panel of the Heat Pump. Dependent upon the installation type, the water will drain to ground or a dedicated drainage point.

Cold Start Function:

With the Heat Pump in Standby Mode, if at any time a heating demand is initiated and the primary heating circuit water temperature is below 17°C, then the Heat Pump will not commence operation. As at these water temperatures, deterioration of the appliance may be caused upon start-up.

The Cold Start Function automatically enables and uses alternative energy sources, dependent upon the installation, to heat the primary heating circuit allowing the heat pump to resume operation.

Dependent upon the system configuration the following solutions may provide this function.

System with DHW Cylinder:

If there is a DHW cylinder installed, during this event, the Heat Pump circulator pump and DHW cylinder back up heater will operate only to increase the primary circuit water temperature. Once 22 °C is achieved the DHW back up heater will be terminated, and normal Heat Pump operation may then resume.

No DHW Cylinder:

If no DHW cylinder is installed, a supplementary back up immersion heater installed within the primary heating circuit must be fitted to provide this function. In this event the supplementary back up heater will operate in the same way detailed above and heat the primary heating circuit water to 22 °C, at which point the supplementary back up heater will be terminated, and normal

Heat Pump operation may then resume.

Combi - Boiler Back Up:

When using a combustion Combi-Boiler configuration with no DHW cylinder, the boiler will operate to provide this functionality. In this event the boiler will operate in the same way detailed above and heat the primary heating circuit water to 22 °C, at which point the boiler operation will be terminated and normal Heat Pump operation may then resume.

Frost Protection (Appliance):

Note: Only if the appliance is in standby mode and with no DHW or space heating demand.

If the outdoor air temperature is $\leq 1^{\circ}\text{C}$, Plant Frost Protection will be initiated. During this event, the Heat Pump circulator pump and central heating zone pumps (if applicable) will operate continuously to prevent the primary heating water from freezing.

If the outdoor air temperature is $\leq 1 - 5^{\circ}\text{C}$, Plant Frost Protection will be initiated. During this event, the Heat Pump circulator pump and central heating zone pumps (if applicable) will operate intermittently to prevent the primary heating water from freezing.

Frost Protection (Condenser):

If the primary circuit water temperature is $\leq 4^{\circ}\text{C}$ and the Heat Pump has power but is in Standby Mode i.e., no DHW, CH or Anti-Legionella demand, Condenser Frost Protection will be initiated. Firstly, the Heat Pump circulator pump will initiate, if after a defined time period, the primary circuit water temperature is still $\leq 4^{\circ}\text{C}$ the backup heater will initiate to raise the temperature to 22 °C. Once this temperature is achieved the backup heater will be terminated and normal Heat Pump operation may then resume. Note: The backup heater utilised in this mode will depend upon the system configuration (refer to Section 2.7.6 *Cold Start Function on page 22* for available solutions).

Frost Protection (Dwelling):

If the temperature of the dwelling is $\leq 8^{\circ}\text{C}$, the room frost protection mode will be initiated to prevent damage to the central heating system. During this event, the Central Heating zone pumps will be operated intermittently.

Weather Compensation:

Weather compensation regulates and maintains optimum flow temperatures which allows the heat pump to run more efficiently. This function will modulate the water flow temperature relative to the external ambient temperatures. The lower the outdoor air temperature, the higher the flow temperature and vice versa.

There are two types of weather compensation available and as described below:

Weather Compensation Alone:

With this mode selected, the primary flow temperature is calculated based on a heating curve, depending only on the average outside temperature. The weather compensation function is initiated with a permanently enabled outdoor temperature sensor (QAC 34) supplied with the Heat Pump system.

Combined Weather Compensation & Room Compensation:

With this mode selected, the primary flow temperature is calculated based upon a heating curve and dependent upon the ambient air temperature and the dwelling room temperature. The current room temperature and its variation from the actual setpoint is acquired and considered when controlling the heat pump flow temperature. This way, consideration is given to room temperature deviations, ensuring more accurate room temperature control and optimum efficiency.

6. BASIC LOGIC AIR CONTROLLER AND DISPLAY FUNCTIONS

The Heat Pump controls are located on the front of the control box. This is the centralised control for the full heating system.

① **IMPORTANT:** To use the control screen the dial can be rotated clockwise to move selection downwards, anti-clockwise to move selection upwards, and pressed to select. When options are selected, the dial can be turned to cycle through the setting options. To exit menus or return to previous screens, a selectable option will be displayed at the bottom of the screen.

- Rotate the dial clockwise for downwards selection
- Rotate the dial anti-clockwise for upwards selection
- Press the dial to make selection

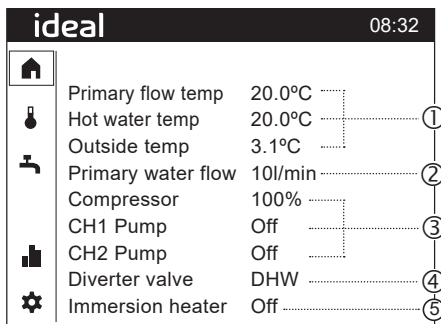
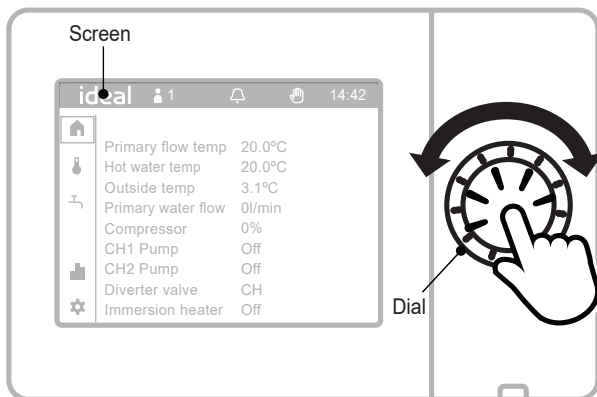

STATUS SYMBOLS	
	Symbol 'Alarm' indicates a plant error.
	Symbol 'Maintenance/Special operations' indicates the presence of a maintenance message or special operation feedback.
	Symbol 'Event' indicates an event message from the plant.
	'Hand' symbol The 'Hand' symbol is displayed if the plant/zone switch setting is changed by making an adjustment on the topic pages. Adjustments made on the topic pages can be reset at the plant/zone switch.
12:00	The device clock is synchronized with the clock from the connected controller.
	Symbol 'User' and the number to the right (access level 1 to 3) indicate which user level is currently active. <ul style="list-style-type: none"> • 1: Commissioning engineer • 2: Heating engineer • 3: OEM
	Symbol 'Producer' indicates the main producer (e.g. oil/gas boiler, heat pump) that is currently switched on.
NAVIGATION SYMBOLS	
	Default Screen
	Space Heating
	Domestic Hot Water
	System Information
	Settings Menu
	Return to Previous Screen
	Test Function
	Installer Functions
OPERATING MODES	
①	Operating Temperatures
②	Water Flow from Heat Pump to Indoor Unit
③	Heat Pump Output
④	Hot Water and Central Heating System Control Actuator Status
⑤	Details on Immersion Heater - On/Off

Creating a Space Heating Demand:

The Space Heating function will be controlled via the use of a Logic Halo Air or equivalent Programmable Room Thermostat (PRT). ON/OFF Room Thermostats are not recommended to be used in conjunction with this appliance as they may negatively affect the system performance and provide no optimisation potential.

Increase the room temperature setpoint until the space heating system switches ON.

Decrease the room temperature setpoint until the space heating system switches OFF.

Domestic Hot Water Heat Demand:

The below figure is the main menu screen and displays the heating system information and status.

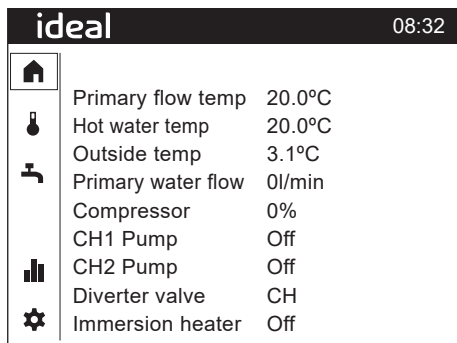

Rotate the dial to highlight functions and change values, press the dial to select the function and confirm changes. To create a hot water demand, select the tap 🚰 icon in the left-hand column.

The following screen will be shown:

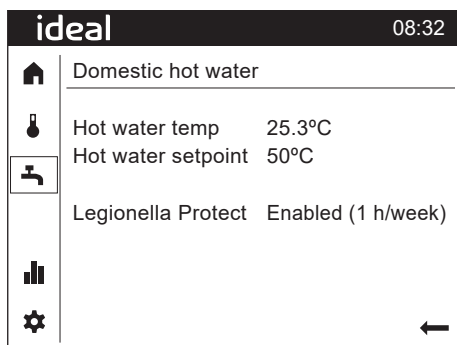

To change the setpoint, select the setpoint function and increase the value to 65°C. Next return to the home screen by selecting the back arrow and then the home symbol. The display will change to the following:

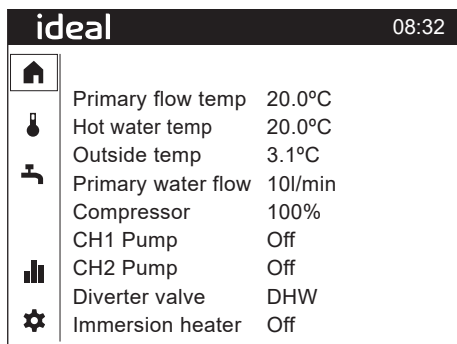

SETTING THE CENTRAL HEATING TIME PROGRAM

On/Off non-programmable room stats only

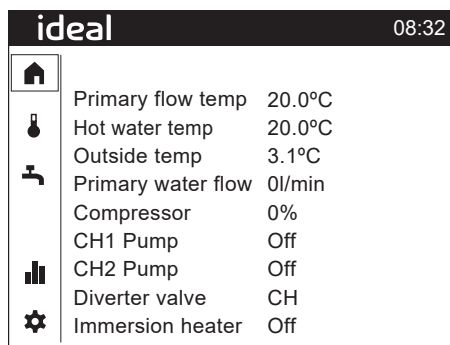

Starting from the Home Screen (see above), to set a central heating programme, rotate the dial until the thermometer icon in the left-hand column is highlighted and press the dial. The following screen will be shown:-

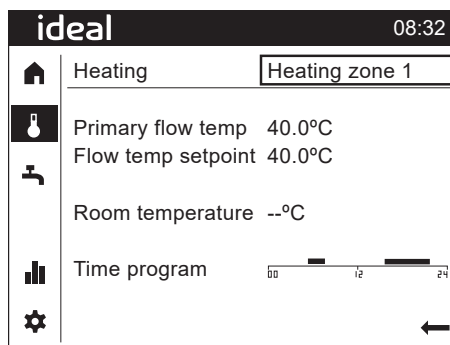

Press the dial and then rotate the dial until the desired central heating zone is shown then press the dial again, rotate the dial until the Time program is highlighted and then press the dial again. The following screen will be shown:-

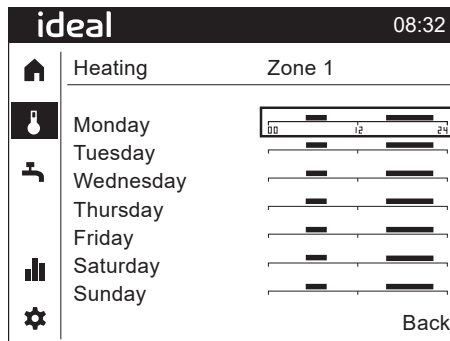

Rotate the dial until the desired day for setting is shown and then press the dial.

The following screen will be shown:

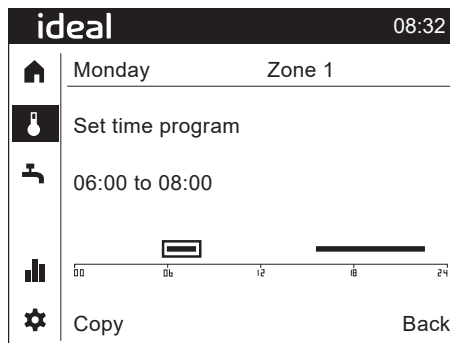

Move the highlighted area to the time you wish to change using the dial and press the dial, then rotate the dial to change the time and press the dial to save.

SETTING TIME/DATE

ideal		08:32
	Primary flow temp	20.0°C
	Hot water temp	20.0°C
	Outside temp	3.1°C
	Primary water flow	0l/min
	Compressor	0%
	CH1 Pump	Off
	CH2 Pump	Off
	Diverter valve	CH
	Immersion heater	Off

Starting from the Home Screen (see above), to set time/date, rotate the dial until the settings icon in the left-hand column is highlighted and select. The following screen will be shown:-

ideal		08:32
	Set Time/Date	
	Special operations	
	User settings	
	User information	
	Installer	
	←	

Rotate the dial until Set Time/Date is highlighted and then press the dial and the following screen will be shown:-

ideal		08:32
	Set Time/Date	
	Time	
		08:32
	Date	
		06.05.2022
	Back	

Rotate the dial until the Time is highlighted and press the dial then rotate the dial to change the time and press the dial to save.

Rotate the dial until the Date is highlighted and press the dial then rotate the dial to change the date and press the dial to save.

SWITCHING THE DHW IMMERSION HEATER ON

ideal		08:32
	Primary flow temp	20.0°C
	Hot water temp	20.0°C
	Outside temp	3.1°C
	Primary water flow	0l/min
	Compressor	0%
	CH1 Pump	Off
	CH2 Pump	Off
	Diverter valve	CH
	Immersion heater	Off

Starting from the Home Screen (see above), to switch the DHW immersion heater on, rotate the dial until the settings icon in the left-hand column is highlighted and press the dial. The following screen will be shown:-

ideal		08:32
	Set Time/Date	
	Special operations	
	User settings	
	User information	
	Installer	
	←	

Rotate the dial until Set Special operations is highlighted and then press the dial and the following screen will be shown:-

ideal		08:32
	Special operations	
	Emergency Mode	Off
	Back	

Rotate the dial until the Emergency Mode setting is highlighted and press the dial then turn the dial to change the setting and press the dial to save

7. LOGIC AIR ALARMS

CHANGING THE COMFORT SETPOINT

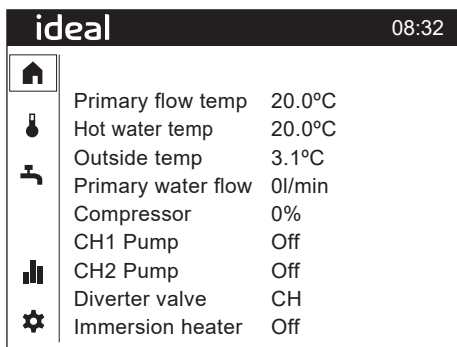

Starting from the Home Screen (see above), to change the Comfort setpoint, rotate the dial until the settings icon in the left-hand column is highlighted and press the dial. The following screen will be shown:-

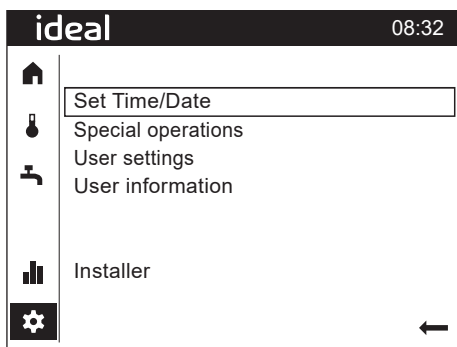

Rotate the dial until User settings is highlighted and then press the dial and the following screen will be shown:-

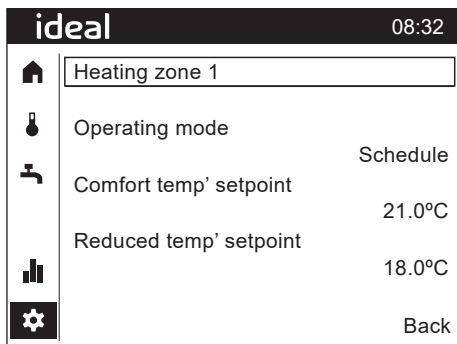

Press the dial and rotate the dial until the desired central heating zone is shown then press the dial. Rotate the dial until the temperature is highlighted and press the dial then rotate the dial to change the temperature and press the dial to save.

Any active faults will be displayed on the home screen. A bell icon will display in the upper part of the control screen.

Active alarms can be viewed by following the instruction below:

Starting from the Home Screen, navigate to the System Information in the left-hand column and select. The following screen will be shown: -

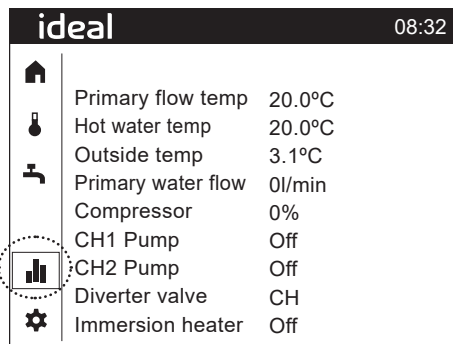

Any active alarms will then be displayed. If multiple alarms are active at the same time these will be shown on additional screens which can be navigated to individually.

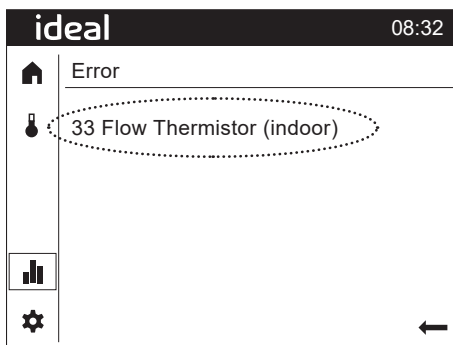

8. FAULT CODES

Fault ID No.	Fault Description
10	Outside Sensor Fault
26	Header Thermistor Fault
33	Flow Thermistor (Indoor) Fault
44	Return Thermistor Fault
50	DHW Thermistor Fault
60	Room Stat 1 Fault
65	Room Stat 2 Fault
81	LPB short-circuit/comm Fault
82	LPB address collision Fault
83	BSB short circuit Fault
84	BSB address collision
100	2 clock time masters Fault
102	Clock without backup Fault
126	7093 DHW Setpt Fault
127	Anti-Legionella Temp' Fault
134	Re-occurring Heat Pump Fault
146	Configuration error
171	Alarm contact 1 active Fault
366	Room temp sensor Fault
369	External Fault
385	Low Mains Voltage Fault
489	No Cascade Master Fault
490	No outdoor connection Fault
499	No outdoor connection Fault
506	Boiler no temp' rise Fault
516	No outdoor connection Fault
7	No heat pump starts exceeded
	No Hot Water
	No Central Heating
	No Display
370	Heat Pump fault:- F0 No outdoor connection fault
370	Heat Pump fault:- F1 No outdoor connection fault
370	Heat Pump fault:- F2 Outdoor HX thermistor fault
370	Heat Pump fault:- F3 Heat Pump inverter fault
370	Heat Pump fault:- F4 Outdoor electrical filtering fault
370	Heat Pump fault:- F5 Outdoor discharge thermistor
370	Heat Pump fault:- F6 Compressor Thermistor fault
370	Heat Pump fault:- F7 Outdoor intermediate HX thermistor
370	Heat Pump fault:- F8 Outdoor outlet HX thermistor
370	Heat Pump fault:- F9 Heat Pump defrost thermistor fault
370	Heat Pump fault:- F10 Outdoor heatsink thmr fault
370	Heat Pump fault:- F11 outdoor PFC thermistor fault
370	Heat Pump fault:- F12 Outdoor exp valve thmr
370	Heat Pump fault:- F13 Outdoor electrical error
370	Heat Pump fault:- F14 outdoor pressure sensor fault
370	Heat Pump fault:- F15 Heat Pump air flow fault
370	Heat Pump fault:- F16 Heat Pump compressor fault
370	Heat Pump fault:- F17 Heat Pump fan fault
370	Heat Pump fault:- F18 Outdoor discharge temp'
370	Heat Pump fault:- F19 compressor temperature fault
370	Heat Pump fault:- F20 outdoor low pressure
370	Heat Pump fault:- F21 outdoor power supply fault
370	Heat Pump fault:- F22 no outdoor connection
370	Heat Pump fault:- F23 hydraulic HX temperature
370	Heat Pump fault:- F24 Circulation pump error
370	Heat Pump fault:- F25 Outdoor Hx Thermistor
370	Heat Pump fault:- F26 Flow sensor error
370	Heat Pump fault:- F27 no water flow fault

9. TROUBLESHOOTING

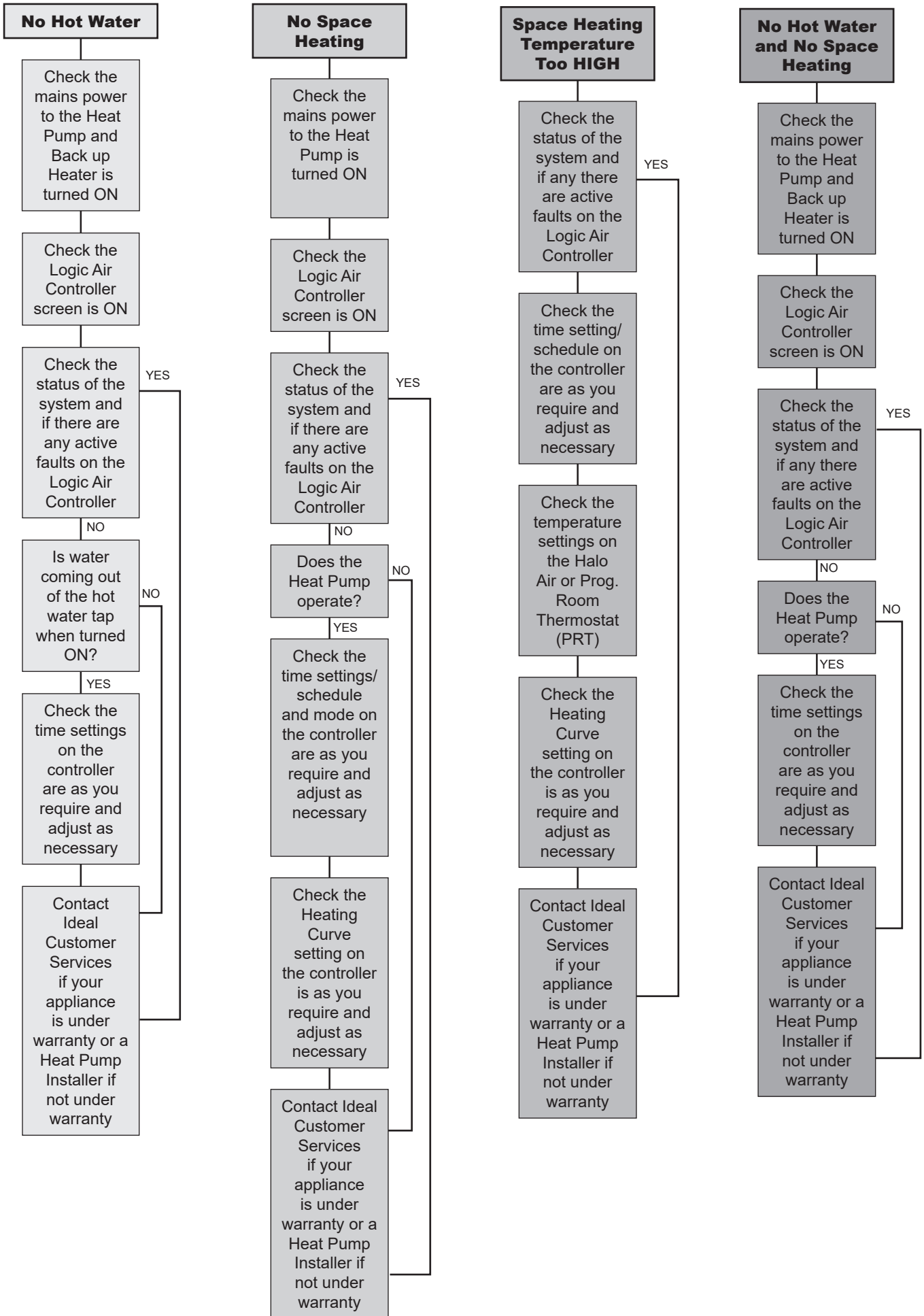

10. WARRANTY

At the end of each 12-month period after commissioning, the Heat Pump must be serviced by a suitable competent heat pump engineer in accordance with the process in the manufacturer's instructions. Should this condition not be met the Heat Pump warranty will lapse.



At Ideal Heating we take our environmental impact seriously, therefore when installing any Ideal Heating product please make sure to dispose of any previous appliance in an environmentally conscious manner. Households can contact their local authority to find out how. See <https://www.gov.uk/managing-your-waste-an-overview> for guidance on how to efficiently recycle your business waste.

Technical Training

Our Expert Academy offer a range of training options designed and delivered by our experts in heating. For details please visit: expert-academy.co.uk

Ideal Boilers Ltd., pursues a policy of continuing improvement in the design and performance of its products. The right is therefore reserved to vary specification without notice.

Ideal is a trademark of Ideal Boilers.

Registered Office

Ideal Boilers Ltd., National Avenue, Hull, East Yorkshire, HU5 4JB

Tel 01482 492251 Fax 01482 448858

Registration No. London 322 137

EU Authorised Representative:

Atlantic SFDT

44 Boulevard des Etats-Unis, 85 000 La Roche-Sur-Yon, France

+33 (0)2 51 44 34 34

Ideal Technical Helpline: 01482 498663

Ideal Consumer Helpline: 01482 498660

Ideal Parts: 01482 498665

idealheating.com

ideal
HEATING