



# INSTALLATION & SERVICING

**VOGUE COMBI GEN2  
C26 C32 C40**

When replacing any part on this appliance, use only spare parts that you can be assured conform to the safety and performance specification that we require. Do not use reconditioned or copy parts that have not been clearly authorised by Ideal Heating.

For the very latest copy of literature for specification and maintenance practices visit our website [idealheating.com](http://idealheating.com) where you can download the relevant information in PDF format.



**ERP DATA**

	SYMBOL	UNITS	MODEL		
			C26	C32	C40
Condensing Boiler	n/a	n/a	yes	yes	yes
Low Temperature Boiler	n/a	n/a	no	no	no
B1 Boiler	n/a	n/a	no	no	no
Cogeneration Space Heater	n/a	n/a	no	no	no
Equipped with a Supplementary Heater	n/a	n/a	no	no	no
Combination Heater	n/a	n/a	yes	yes	yes
<b>Nominal Heat Output for Space Heating</b>					
Full Load	P <sub>4</sub>	kW	18	26	32
Part Load	P <sub>1</sub>	kW	5.9	8.5	10.4
<b>Auxiliary Electricity Consumption</b>					
Full Load	e <sub>lmax</sub>	kW	0.047	0.063	0.044
Part Load	e <sub>lmin</sub>	kW	0.014	0.011	0.01
Standby	P <sub>SB</sub>	kW	0.003	0.003	0.003
<b>Seasonal Space Heating Energy Efficiency</b>					
Full Load	η <sub>4</sub>	%	89.7	89.9	89.7
Part Load	η <sub>1</sub>	%	97.7	97.8	97.5
Standby Loss	P <sub>stby</sub>	kW	0.02	0.02	0.02
Ignition	P <sub>ign</sub>	kW	0	0	0
<b>Emissions</b>					
Nox (Gross)	NO <sub>x, pond Hs</sub>	mg/kWh	34	52	44
Annual Energy Consumption	Q <sub>HE</sub>	GJ	56	81	99
Sound Power Level, Indoors	L <sub>WA</sub>	dB	47	50	49
<b>Domestic Hot Water</b>					
Domestic Hot Water	Q <sub>elec</sub>	kWh	0.154	0.159	0.193
Water heating energy efficiency (Eco) Tapping Profile XL	η <sub>WH</sub>	%	86	85	85
Daily fuel consumption 24hr (GCV) Actual measured	Q <sub>fuel</sub>	kWh	22.641	22.858	23.002
Annual electricity consumption	AEC	kWh	33	34	33
Annual fuel consumption	AFC	GJ	17	17	17

# PRODUCT FICHE

## VOGUE COMBI GEN2 BOILER

Ideal Heating

### ERP DATA

	SYMBOL	UNITS	MODEL		
			C26	C32	C40
Condensing boiler			Yes		
Seasonal Space heating efficiency class			A		
Rated heat output		kW	18	26	32
Seasonal space heating energy efficiency	$\eta_s$	%	93*	93*	93*
Annual energy consumption	$Q_{HE}$	GJ	56	81	99
Sound power level, indoors	$L_{WA}$	dBA	47	50	49
Water heating energy efficiency class			A		

<b>Seasonal Space Heating Energy Efficiency of the Boiler</b>								*%	<b>A</b>
<b>Temperature control (from fiche of temperature control)</b>								%	
<i>Class I</i>	<i>Class II</i>	<i>Class III</i>	<i>Class IV</i>	<i>Class V</i>	<i>Class VI</i>	<i>Class VII</i>	<i>Class VIII</i>	<b>B</b>	
1%	2%	1.5%	2%	3%	4%	3.5%	5%		

### Solar Contribution (from fiche of solar device)

Collector Size  
(in m<sup>2</sup>)

Tank Volume  
(in m<sup>3</sup>)

Collector Efficiency  
(in %)

Tank rating  
A\* = 0.95  
A = 0.91  
B = 0.86  
C = 0.83  
D-G = 0.81

= ('III' x  + 'IV' x ) x 0.9 x ( / 100 x ) = % **C**

Seasonal Space Heating Energy Efficiency of Package

**TOTAL: A+B+C=**

%

### Seasonal Space Heating Energy Efficiency Class of Package

<input style="width: 20px; height: 20px;" type="checkbox"/>	<input style="width: 20px; height: 20px;" type="checkbox"/>	<input style="width: 20px; height: 20px;" type="checkbox"/>	<input style="width: 20px; height: 20px;" type="checkbox"/>	<input style="width: 20px; height: 20px;" type="checkbox"/>	<input style="width: 20px; height: 20px;" type="checkbox"/>	<input style="width: 20px; height: 20px;" type="checkbox"/>	<input style="width: 20px; height: 20px;" type="checkbox"/>	<input style="width: 20px; height: 20px;" type="checkbox"/>	<input style="width: 20px; height: 20px;" type="checkbox"/>
<b>G</b>	<b>F</b>	<b>E</b>	<b>D</b>	<b>C</b>	<b>B</b>	<b>A</b>	<b>A+</b>	<b>A++</b>	<b>A+++</b>
< 30%	≥ 30%	≥ 34%	≥ 36%	≥ 75%	≥ 82%	≥ 90%	≥ 98%	≥ 125%	≥ 150%

The energy efficiency of the package of products provided for in this document may not correspond to its actual energy efficiency once installed in a building, as the efficiency is influenced by further factors such as heat loss in the products in relation to the building size and its characteristics



## NOTES FOR THE INSTALLER

**FOR ANY TECHNICAL QUERIES PLEASE RING THE  
IDEAL INSTALLER HELPLINE : 01482 498663**

**NOTE. BOILER RESTART PROCEDURE -**

To restart the boiler, press RESTART button on the control panel. The boiler will repeat the ignition sequence if a heat demand is present

## DOCUMENT AMENDMENTS

Relevant Installation changes implemented in this book from Mod Level..... A04 (Aug 21) to A06 (Jul 23)

All instances of IEE or I.E.E now changed to IET.

Destination Country page 9 changed from 'UK' to 'GB'.



# CONTENTS

<b>1</b>	<b>INTRODUCTION.....</b>	<b>10</b>			
1.1	Introduction .....	10	3.2	Boiler Front Panel Removal / Replacement .....	50
1.2	Operation .....	10	3.3	Lowering the Controls Panel .....	50
1.3	Safe Handling.....	10	3.4	Fan & Venturi Assembly Removal & Cleaning .....	51
1.4	Optional Extra Kits .....	11	3.5	Removal of Injector .....	51
1.5	Safety .....	11	3.6	Burner Removal & Cleaning.....	52
1.6	Safe Handling of Substances.....	11	3.7	Cleaning the Condensate Trap / Siphon .....	52
1.7	Location of Boiler .....	12	3.8	Cleaning the Heat Exchanger .....	53
1.8	Carbon Monoxide Alarms .....	12	3.9	Re-Assembly.....	53
1.9	Gas Supply.....	12	3.10	Replacement of Components.....	54
1.10	Flue Installation .....	13	3.11	Fan Replacement.....	54
1.11	Terminal.....	13	3.12	Burner Injector Replacement .....	55
1.12	Air Supply.....	13	3.13	Burner/Door Assembly Replacement .....	55
1.13	Water Circulation System.....	13	3.14	Return Thermistor Renewal .....	55
1.14	Boiler Control Interlocks .....	13	3.15	Ignition Electrode Replacement .....	56
1.15	Electrical Supply.....	14	3.16	Flame Detection Electrode Replacement.....	56
1.16	Condensate Drain .....	14	3.17	Spark Generator Replacement .....	57
1.17	Boiler Dimensions, Services & Clearances.....	15	3.18	Gas Control Valve Replacement .....	57
1.18	System Requirements.....	16	3.19	Diverter Valve Actuator Replacement .....	58
1.19	System Balancing .....	17	3.20	Condensate Trap Replacement .....	58
1.20	Water Treatment.....	17	3.21	PCB Replacement.....	59
<b>2</b>	<b>INSTALLATION .....</b>	<b>18</b>	3.22	User PCB Replacement.....	60
2.1	Boiler Assembly - Exploded View.....	18	3.23	DHW Flow Turbine Sensor Replacement .....	60
2.2	Unpacking .....	19	3.24	Draining the Boiler.....	60
2.3	Front Panel Removal .....	20	3.25	Pressure Gauge Renewal .....	61
2.4	Wall Mounting Template .....	21	3.26	Pressure Relief Valve Renewal.....	61
2.5	Preparing the Wall.....	21	3.27	Pump Auto Air Vent Replacement .....	62
2.6	Fitting the Wall Mounting Plate.....	21	3.28	Diverter Valve Internal Cartridge Replacement.....	62
2.7	Mounting the Boiler .....	21	3.29	DHW Plate Heat Exchanger Replacement .....	63
2.8	Determining the Flue Length & Flue Packs Req'd .....	22	3.30	Pump Head Replacement.....	63
2.9	Cutting & Setting the Flue Length .....	24	3.31	CH Water Pressure Sensor Replacement.....	63
2.10	Installing the Flue .....	25	3.32	DHW Filter & Flow Regulator Cleaning/Replacement.....	64
2.11	Condensate Drain .....	26	3.33	Flow Thermistor Replacement .....	64
2.12	Fitting the Optional Roof Flue Kit (Flat or Pitched).....	28	3.34	Heat Exchanger Replacement .....	65
2.13	Flue Terminal Position.....	29	3.35	Expansion Vessel Recharging and Replacement .....	66
2.14	Assembling the Roof Flue Kit.....	30	3.36	Boiler Sealing Panel Replacement.....	66
2.15	Connections & Filling .....	31	<b>4</b>	<b>FAULT FINDING .....</b>	<b>67</b>
2.16	Electrical Connections.....	33	4.1	Fault Finding Chart Main Menu.....	67
2.17	Installer Wiring - Mains.....	33	4.2	Overheat Lockout.....	68
2.18	Optional System Controls Kits .....	34	4.3	Ignition Lockout .....	68
2.19	Internal Wiring - External Controls .....	34	4.4	Flame Loss.....	69
2.20	External Wiring.....	35	4.5	Thermal Fuse Lockout .....	69
2.21	Replacing Pre-Fitted Mains Cable .....	35	4.6	Flame On Before Gas Valve On.....	70
2.22	Wiring Diagram .....	36	4.7	Flow Thermistor Fault .....	70
2.23	Commissioning And Testing .....	37	4.8	Outside Sensor Fault .....	70
2.24	Initial Lighting .....	38	4.9	Return Thermistor Fault .....	71
2.25	Check CH & DHW Operation.....	39	4.10	Fan Fault .....	71
2.26	Display Functions In Normal Operation .....	40	4.11	Low Water Pressure.....	71
2.27	Changing Settings.....	41	4.12	No Water Flow.....	71
2.28	Menu Operation .....	42	4.13	No Connection To Primary PCB.....	72
2.29	General Checks .....	47	4.14	No CH But DHW Ok.....	72
2.30	Handing Over .....	48	4.15	No DHW But CH Ok.....	73
<b>3</b>	<b>SERVICING .....</b>	<b>49</b>	4.16	Blank Display .....	73
3.1	Servicing Schedule .....	49	<b>5</b>	<b>SPARE PARTS .....</b>	<b>74</b>
			<b>6</b>	<b>BENCHMARK .....</b>	<b>75</b>

# SECTION 1 - GENERAL

**Table 1 - General Data**

		C26	C32	C40
Gas supply		2H - G20 - 20mbar		
Gas Supply Connection		22mm copper compression		
Injector Size	mm	4.30	4.40	5.15
Inlet Connection	Domestic Hot Water	15mm copper compression		
Outlet Connection	Domestic Hot Water	15mm copper compression		
Flow Connection	Central Heating	22mm copper compression		
Return Connection	Central Heating	22mm copper compression		
Flue Terminal Diameter	mm	100		
Average Flue Temp-Mass Flow Rate (DHW)	°C (g/s)	73°C (11 g/s)	73°C (13 g/s)	70°C (17 g/s)
CO <sub>2</sub> Content (± 0.7)	Max. DHW	9.4 %	9.8 %	9.6 %
	Min. DHW	8.0 %	8.5 %	8.1 %
Maximum CH Working Pressure (Sealed Systems)	bar	2.5		
Maximum DHW Inlet Working Pressure	bar	10.0		
Minimum DHW Flow Rate	l/min	1.9	1.9	1.9
*Required Connection Pressure for Minimum Flow Rate	bar	0.03	0.03	0.03
DHW Flow Rate at 35°C Temp Rise	l/min	10.65	13.1	16.4
*Required Connection Pressure for 35°C Temp Rise	bar	0.62	0.83	1.23
80% of Max Flow Rate	l/min	8.52	10.48	13.12
*Required Connection Pressure for 80% of Max Flow Rate	bar	0.39	0.54	0.79
Electrical Supply		230 V ~ 50 Hz.		
Power Consumption	W	94	115	96
Fuse Rating		External : 3A Internal : 4A Time Delay		
Water content	Central Heating litre	1.5	1.8	2.2
	Domestic Hot Water litre	0.5		
Packaged Weight	kg	37.6	38.9	40.9
Maximum Installation Weight	kg	32.4	33.8	35.4
Boiler Casing Size	Height mm	740		
	Width mm	445		
	Depth mm	330		
Heat Exchanger Weight without Burner	kg	7.3	8.2	9.5

\* In areas of low water pressure the DHW restrictor can be removed

**Table 2 - Performance Data - Central Heating**

Boiler Input :		Max.			Min.		
		C26	C32	C40	C26	C32	C40
Boiler Input 'Q'	Nett CV kW	18.1	26.1	32.1	3.7	4.6	5.7
	Gross CV kW	20.1	29.0	35.6	4.1	5.1	6.3
Gas Consumption	m <sup>3</sup> /h	1.869	2.695	3.314	0.383	0.472	0.590
Boiler Output :							
Non Condensing	kW	18.0	26.0	32.0	3.7	4.6	5.7
70°C Mean Water temp.							
Condensing	kW	19.3	27.9	34.3	4.0	4.9	6.1
40°C Mean Water temp.							
Seasonal efficiency* SEDBUK 2005		91.0	91.1	91.0		n/a	
Seasonal efficiency* SEDBUK 2009		89.1	89.2	89.1		n/a	
NOx Classification		Class 6					

**Table 3 - Performance Data - Domestic Hot Water**

Maximum DHW Input :		C26	C32	C40
Nett CV	kW	26.1	32.1	40.2
Gross CV	kW	29.0	35.6	44.6
Gas Consumption	m <sup>3</sup> /h	2.695	3.314	4.150
Maximum DHW Output	kW	26.0	32.0	40.0
DHW Flow Rate at 35°C temp. rise.	l/min	10.6	13.1	16.4
DHW Specific Rate	l/min	12.4	15.3	19.1

\* The value is used in the UK Government's Standard Assessment Procedure (SAP) for energy rating of dwellings. The test data from which it has been calculated have been certified by a notified body.

**Note.** Gas consumption is calculated using a calorific value of 38.7 MJ/m<sup>3</sup> gross or 34.9 MJ/m<sup>3</sup> nett

To obtain the gas consumption at a different calorific value:

- For l/s - divide the gross heat input (kW) by the gross C.V. of the gas (MJ/m<sup>3</sup>)
- For ft<sup>3</sup>/h - divide the gross heat input (Btu/h) by the gross C.V. of the gas (Btu/ft<sup>3</sup>)
- For m<sup>3</sup>/h - multiply l/s by 3.6

**Key to symbols**

**GB** = United Kingdom    **IE** = Ireland    (Countries of destination)

**PMS** = Maximum operating pressure of water

**C<sub>13</sub> C<sub>33</sub> C<sub>53</sub>\*** = A room sealed appliance designed for connection via ducts to a horizontal or vertical terminal, which admits fresh air to the burner and discharges the products of combustion to the outside through orifices which, in this case, are concentric. The fan is up stream of the combustion chamber. (\*Note. C<sub>53</sub> covers optional high level and balcony flue kits only.)

**I<sub>2H</sub>** = An appliance designed for use on 2nd Family gas, Group H only.



**VOGUE COMBI GEN2**

Natural Gas only

Boiler size	G.C. Appliance No. (Benchmark No.)
C26	47-349-38
C32	47-349-39
C40	47-349-40

Destination Country: GB, IE

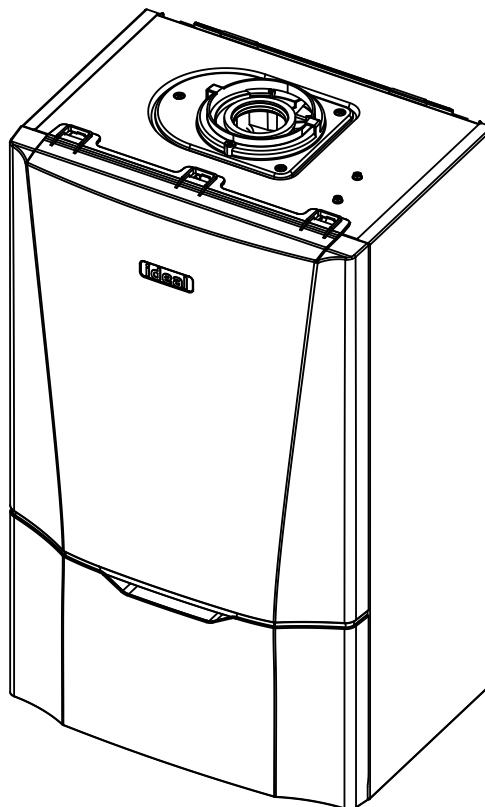

For GB, to comply with Building Regulations Part L1 (Part 6 in Scotland) the boiler should be fitted in accordance with the manufacturer's instructions. Self-certification that the boiler has been installed to comply with Building Regulations can be demonstrated by completing and signing the Benchmark Commissioning Checklist.

Before installing this boiler, read the Code of Practice sheet at the rear of this book.

**BENCHMARK COMMISSIONING CHECKLIST DETAILS**

Boiler	Page	Page	
Make and model.....	9	Burner operating pressure .....	n/a
Appliance serial no. on data badge .....	Front Cover	Central heating flow temp. ....	measure and record
SEDBUK No. %.....	8	Central heating return temp. ....	measure and record
<b>Controls</b>		<b>For combination boilers only</b>	
Time and temperature control to heating .....	33	Scale reducer .....	16
Time and temperature control to hot water .....	33	<i>Hot water mode</i>	
Heating zone valves.....	n/a	Heat input.....	to be calculated
TRV's.....	13	Max. operating burner pressure .....	n/a
Auto bypass .....	13	Max. operating water pressure.....	measure & record
Boiler interlock.....	13	Cold water inlet temp .....	measure & record
<b>For ..... all boilers</b>		Hot water outlet temp .....	measure & record
Flushing to BS.7593.....	16	Water flow rate at max. setting.....	measure & record
Inhibitor .....	16	<b>For condensing boilers only</b>	
<i>Central heating mode</i>		Condensate drain.....	25-26
Heat input.....	to be calculated	<b>For all boilers: complete, sign &amp; hand over to customer</b>	
		For assistance see Technical Helpline on the back page	

**NOTE TO THE INSTALLER: COMPLETE THE BENCHMARK COMMISSIONING CHECKLIST AND LEAVE THESE INSTRUCTIONS WITH APPLIANCE**



## 1.1 INTRODUCTION

The **Vogue Combi GEN2** range of boilers are wall mounted, full sequence, automatic spark ignition, low water content, fanned flue, high efficiency, condensing, combination gas boilers.

**Note.** *Due to the high efficiency of the boiler a plume of water vapour will form at the terminal during operation.*

Central heating (CH) output is fully modulating with a range of:

26	3.7 to 18kW
32	4.6 to 26kW
40	5.7 to 32kW

Instantaneous domestic hot water (DHW) output is also fully modulating with a maximum of :

26	26kW
32	32kW
40	40kW

The boiler is supplied fully assembled with DHW plate heat exchanger, diverter valve, circulating pump, pressure gauge, pressure relief valve and CH expansion vessel.

Variable CH and DHW temperature controls are fitted on the user control and the boiler features an optional DHW preheat facility.

The boiler includes as standard:

- Automatic bypass
- Boiler frost protection
- Daily pump and diverter valve exercise.

The boiler casing is of white painted mild steel with a white polymer front panel.

The boiler temperature controls are located behind the lower panel on the front of the boiler.

The heat exchanger is manufactured from stainless steel.

The boiler is suitable for connection to fully pumped, sealed heating systems ONLY. Adequate arrangements for completely draining the system by provision of drain cocks MUST be provided in the installation pipework.

The standard configuration of pipework from the boiler is routed downwards.

## 1.2 OPERATION

With no demand for CH, the boiler fires only when DHW is drawn off, or periodically for a few seconds without any DHW draw-off, in order to maintain the DHW calorifier in a heated condition. This only occurs if pre-heat is selected from the menu.

When there is a demand for CH, the heating system is supplied at the selected temperature of between 30°C and 80°C, until DHW is drawn off. The full output from the boiler is then directed via the diverter valve to the plate heat exchanger to supply a nominal DHW draw-off of

26	10.6 l/min at 35 °C temperature rise.
32	13.1 l/min at 35 °C temperature rise.
40	16.4 l/min at 35 °C temperature rise.

The DHW draw off rate specified above is the nominal that the boiler flow regulator will give. Due to system variations and seasonal temperature fluctuations DHW flow rates/temperature rise will vary, requiring adjustment at the draw off tap.

At low DHW draw-off rate the maximum temperature is limited to 65°C by the modulating gas control.

The boiler features a comprehensive diagnostic system which gives detailed information on the boiler status when operating, and performance of key components to aid commissioning and fault finding.

## 1.3 SAFE HANDLING

This boiler may require 2 or more operatives to move it to its installation site, remove it from its packaging base and during movement into its installation location. Manoeuvring the boiler may include the use of a sack truck and involve lifting, pushing and pulling.

Caution should be exercised during these operations.

Operatives should be knowledgeable in handling techniques when performing these tasks and the following precautions should be considered:

- Grip the boiler at the base.
- Be physically capable.
- Use personal protective equipment as appropriate, e.g. gloves, safety footwear.

During all manoeuvres and handling actions, every attempt should be made to ensure the following unless unavoidable and/or the weight is light.

- Keep back straight.
- Avoid twisting at the waist.
- Avoid upper body/top heavy bending.
- Always grip with the palm of the hand.
- Use designated hand holds.
- Keep load as close to the body as possible.
- Always use assistance if required.

### 1.4 OPTIONAL EXTRA KITS

Please visit [idealheating.com](http://idealheating.com) to access the Flue and Accessories Guide for this boiler.

### 1.5 SAFETY

**Current Gas Safety (installation and use) regulations or rules in force:**

The appliance is suitable only for installation in GB and IE and should be installed in accordance with the rules in force.

In GB, the installation must be carried out by a Gas Safe Registered Engineer. It must be carried out in accordance with the relevant requirements of the:

- Gas Safety (Installation and Use) Regulations
- The appropriate Building Regulations either The Building Regulations, The Building Regulations (Scotland), Building Regulations (Northern Ireland).
- The Water Fittings Regulations or Water byelaws in Scotland.
- The Current IET Wiring Regulations.

Where no specific instructions are given, reference should be made to the relevant British Standard Code of Practice.

In IE, the installation must be carried out by a Registered Gas Installer (RGII) and installed in accordance with the current edition of I.S.813 "Domestic Gas Installations", the current Building Regulations and reference should be made to the current ETCI rules for electrical installation.

Detailed recommendations are contained in the following British Standard Codes of Practice:

- BS. 5440:1** Flues (for gas appliances of rated input not exceeding 70 kW).
- BS. 5440:2** Ventilation (for gas appliances of rated input not exceeding 70 kW).
- BSEN. 12828** Heating Systems in buildings: Design for water based heating systems.
- BSEN. 12831** Heating Systems in buildings: Method for calculation of the design heat load.
- BSEN. 14336** Heating Systems in buildings: Installation and commissioning of water based heating systems.
- BS. 5546** Installation of gas hot water supplies for domestic purposes (2nd Family Gases)
- BS. 6798** Installation of gas fired hot water boilers of rated input not exceeding 70 kW.
- BS. 6891** Low pressure installation pipes.

**Health & Safety Document No. 635.**

**The Electricity at Work Regulations.**

The manufacturer's notes must NOT be taken, in any way, as overriding statutory obligations.

**IMPORTANT.** These appliances are CE certificated for safety and performance. It is, therefore, important that no external control devices, e.g. flue dampers, economisers etc., are directly connected to these appliances unless covered by these Installation and Servicing Instructions or as otherwise recommended by **Ideal Heating** in writing. If in doubt please enquire.

Any direct connection of a control device not approved by **Ideal Heating** could invalidate the certification and the normal appliance warranty. It could also infringe the Gas Safety Regulations and the above regulations.

### 1.6 SAFE HANDLING OF SUBSTANCES

No asbestos, mercury or CFCs are included in any part of the boiler or its manufacture.

## 1.7 LOCATION OF BOILER

The boiler must be installed on a flat and vertical internal wall, capable of adequately supporting the weight of the boiler and any ancillary equipment.

The boiler may be fitted on a combustible wall and insulation between the wall and the boiler is not necessary, unless required by the local authority.

For electrical safety reasons there must be no access available from the back of the boiler.

**The boiler must not be fitted outside.**

### Timber Framed Buildings

If the boiler is to be fitted in a timber Framed building it should be fitted in accordance with the Institute of Gas Engineering document IGE/UP/7 - Edition 2.

### Bathroom Installations

This appliance is rated **IP20**.

The boiler may be installed in any room or internal space, although particular attention is drawn to the requirements of the current IET (BS.7671) Wiring Regulations and the electrical provisions of the building regulations applicable in Scotland, with respect to the installation of the boiler in a room or internal space containing a bath or shower. For IE reference should be made to the current ETCI rules for electrical installations and I.S. 813.

If the appliance is to be installed in a room containing a bath or shower then, providing water jets are not going to be used for cleaning purposes (as in communal baths/showers), the appliance must be installed beyond Zone 2, as detailed in BS.7671.

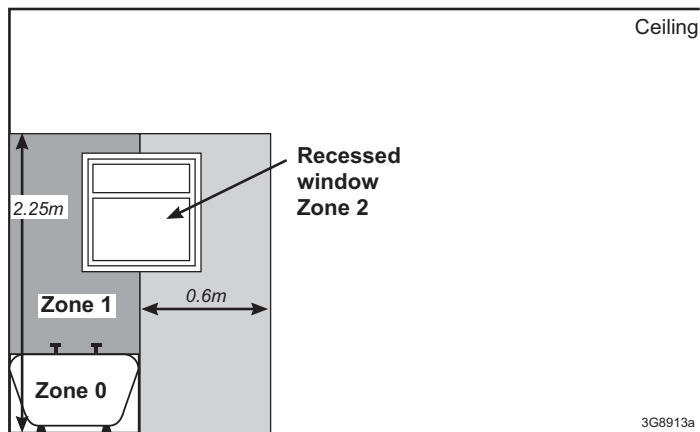

### Compartment Installations

A compartment used to enclose the boiler should be designed and constructed specially for this purpose.

An existing cupboard or compartment may be used, provided that it is modified for the purpose.

Braces for compartments must be easily removable for service access.

In both cases, details of essential features of cupboard / compartment design, including airing cupboard installation, are to conform to the following:

- BS 6798 (No cupboard ventilation is required - see 'Air Supply' for details).
- The position selected for installation **MUST** allow adequate space for servicing in front of the boiler.
- For the minimum clearances required for safety and subsequent service, see the wall mounting template and Section 1.17. In addition, sufficient space may be required to allow lifting access to the wall mounting plate.

## 1.8 CARBON MONOXIDE ALARMS

When installing a new boiler, Installers should make sure that a suitable carbon monoxide alarm is installed near to the boiler.

**IMPORTANT:** Carbon monoxide alarms must be installed in any room that has a fixed combustion appliance.

UK Building Regulations state that a carbon monoxide alarm should be installed in the room where:

- a new or replacement fixed combustion appliance (excluding an appliance used solely for cooking) is installed in the dwelling, or
- a new or replacement fixed combustion appliance is installed in a connected space such as an integral garage.

Users and Installers should comply with the Smoke and Carbon Monoxide Alarm (Amendment) Regulations 2022 and BS EN 50291-1:2010, and all applicable local building authority regulations.

Carbon monoxide detectors should use a battery designed to operate for the working life of the detector. Carbon monoxide detectors that are connected to the main electrical supply and comply with BS EN 50291-1:2010 (Type A) may be used, as long as a sensor failure warning device is installed. All detectors should include a warning device to alert the Users when the working life of the detector is scheduled to end.

## 1.9 GAS SUPPLY

The local gas supplier should be consulted, at the installation planning stage, in order to establish the availability of an adequate supply of gas. An existing service pipe must **NOT** be used without prior consultation with the local gas supplier.

The boiler **MUST** be installed on a gas supply with a governed meter only.

A gas meter can only be connected by the local gas supplier or by a Gas Safe Registered Engineer. In IE by a Registered Gas Installer (RGII).

An existing meter should be checked, preferably by the gas supplier, to ensure that the meter is adequate to deal with the rate of gas supply required.

It is the responsibility of the Gas Installer to size the gas installation pipework in accordance with BS6891. Whilst the principle of the 1:1 gas valve ensures the Vogue Combi GEN2 range is able to deliver its full output at inlet pressures as low as 14mb, other gas appliances in the property may not be as tolerant. When operating pressures are found to be below the minimum meter outlet of 19mb these should be checked to ensure this is adequate for correct and safe operation.

Allowing for the acceptable pressure loss of 1mb across the installation pipework, it can be assumed that a minimum permitted operating pressure of 18mb will be delivered to the inlet of the appliance. (Reference BS 6400-1 Clause 6.2 Pressure Absorption).

The external gas cock could further reduce the operating pressure when measured at its test point. The pressure drop is relative to the heat input to the boiler (kW), refer to graph below.

# SECTION 1 - GENERAL

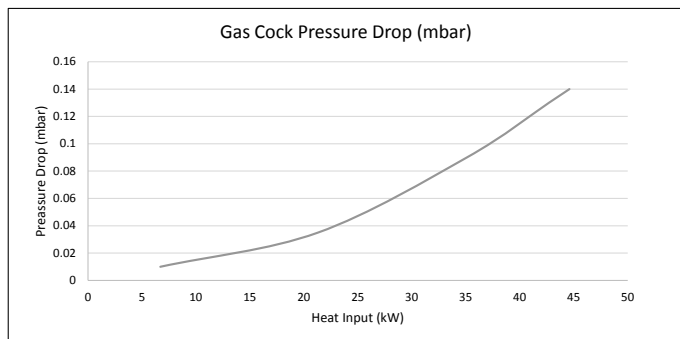

## IMPORTANT.

Ensure all gas valve connections are gas tight with a gas soundness check up to the gas control valve.

Installation pipes must be fitted in accordance with BS.6891. In IE refer to IS.813.

The complete installation MUST be tested for gas tightness and purged as described in the above code.

## 1.10 FLUE INSTALLATION

Plumbing will occur at the terminal so terminal positions where this could cause a nuisance should be avoided.

The flue must be installed in accordance with the recommendations of BS. 5440-1.

In IE refer to I.S. 813.

The following notes are intended for general guidance:

**Table 4 - Balanced Flue Terminal Position**

Flue Terminal Positions	Min. Spacing*
1. Directly below, above or alongside an opening window, air vent or other ventilation opening.	300mm
2. Below guttering, drain pipes or soil pipes. <i>BS5440-1</i>	25mm* 75mm
3. Below eaves. <i>BS5440-1</i>	25mm* 200mm
4. Below balconies or a car port roof. <i>BS5440-1</i>	25mm* 200mm
5. From vertical drain pipes or soil pipes. <i>BS5440-1</i>	25mm* 150mm
6. From an internal or external corner or to a boundary along side the terminal. <i>BS5440-1</i>	25mm* 200mm
7. Above adjacent ground, roof or balcony level.	300mm
8. From a surface or a boundary facing the terminal.	600mm
9. From a terminal facing a terminal.	1,200mm
10. From an opening in a car port (e.g. door or window) into dwelling.	1,200mm
11. Vertically from a terminal on the same wall.	1,500mm
12. Horizontally from a terminal on the wall.	300mm
<b>Vertical Terminals</b>	
13. Above the roof pitch with roof slope of all angles. Above flat roof.	300mm 300mm
14. From a single wall face. From corner walls.	300mm 300mm
15. Below velux window	2000mm
16. Above or side of velux window	600mm

\* Only one reduction down to 25mm is allowable per installation otherwise BS5440-1 dimensions must be followed.

1. The boiler MUST be installed so that the terminal is exposed to external air.
2. It is important that the position of the terminal allows the free passage of air across it at all times.
3. Minimum acceptable spacing from the terminal to obstructions and ventilation openings are specified in Table 4.
4. Where the lowest part of the terminal is fitted less than 2m above a balcony, above ground or above a flat roof to which people have access then the terminal MUST be protected by a purpose designed guard.

Terminal guards are available from boiler suppliers. (Ask for TFC flue guard model no. K6 - round, plastic coated). In case of difficulty contact:

TFC Group Ltd. Tel. + 44 (0) 01732 351 680  
Tower House, Vale Rise Fax. + 44 (0) 01732 354 445  
Tonbridge, Kent TN9 1TB www.tfc-group.co.uk

Ensure that the guard is fitted centrally.

5. The flue assembly shall be so placed or shielded as to prevent ignition or damage to any part of any building.
6. The air inlet/products outlet duct and the terminal of the boiler MUST NOT be closer than 25mm to combustible material. Detailed recommendations on the protection of combustible material are given in BS. 5440-1.

**IMPORTANT.** It is essential to ensure, in practice, that products of combustion discharging from the terminal cannot re-enter the building or buildings through any openings into the building such as ventilators, windows, doors, or other sources of natural air infiltration, such as forced ventilation openings etc.

If products of combustion re-entry is identified or suspected this should be immediately investigated and corrected following the guidance provided in the current Gas Industry Unsafe Situation Procedure.

## 1.11 TERMINAL

The terminal assembly can be adapted to accommodate various wall thicknesses. Refer to Section 2.8.

## 1.12 AIR SUPPLY

It is NOT necessary to have a purpose-provided air vent in the room or internal space in which the boiler is installed. Neither is it necessary to ventilate a cupboard or compartment in which the boiler is installed, due to the low surface temperatures of the boiler casing during operation; therefore the requirements of BS 6798, Clause 12, and BS 5440:2 may be disregarded.

## 1.13 WATER CIRCULATION SYSTEM

### IMPORTANT.

A minimum length of 1 metre of copper pipe MUST be fitted to both flow and return connections from the boiler before connection to any plastic piping.

The central heating system should be in accordance with BS.6798 and, in addition, for smallbore and microbore systems, BS.5449.

### WATER TREATMENT - see Secton 1.20

## 1.14 BOILER CONTROL INTERLOCKS

Central heating systems controls should be installed to ensure the boiler is switched off when there is no demand for heating, in compliance with Building Regulations.

Heating systems utilising full thermostatic radiator valve control of temperature in individual rooms should also be fitted with a room thermostat controlling the temperature in a space served by radiators not fitted with such a valve.

When thermostatic radiator valves are used, the space heating temperature control over a living / dining area or hallway having a heating requirement of at least 10% of the minimum boiler heat output should be achieved using a room thermostat, whilst other rooms are individually controlled by thermostatic radiator valves. However, if the system employs thermostatic radiator valves on all radiators, or two port valves, then a bypass circuit external to the boiler must be fitted with an automatic bypass valve to ensure a flow of water should all valves be in the closed position.

### 1.15 ELECTRICAL SUPPLY

#### **WARNING.**

This appliance must be earthed.

Wiring external to the appliance MUST be in accordance with the current IET (BS.7671) Wiring Regulations and any local regulations which apply. For IE reference should be made to the current ETCI rules for electrical installations.

The mains supply to the boiler and system wiring centre shall be through one common fused double pole isolator and for new heating systems, and where practical replacement installations, the isolator shall be situated adjacent to the appliance.

### 1.16 CONDENSATE DRAIN

#### **Refer to Section 2.11**

A condensate drain is provided on the boiler. This drain must be connected to a drainage point on site. All pipework and fittings in the condensate drainage system MUST be made of plastic - *no other materials may be used.*

#### **IMPORTANT.**

Installation must be in accordance with BS 6798.

The drain outlet on the boiler is sized for standard 21.5mm overflow pipe. It is a universal fitting to allow use of different brands of pipework.

# SECTION 1 - GENERAL

## 1.17 BOILER DIMENSIONS, SERVICES & CLEARANCES

*all dimensions in mm*

The boiler connections are made on the boiler connection tails. Refer to Section 2.15.

The following minimum clearances must be maintained for operation and servicing.

**Additional space will be required for installation, depending upon site conditions.**

### Side and Rear Flue

a. Provided that the flue hole is cut accurately, e.g. with a core drill, the flue can be installed from inside the building where

wall thicknesses do not exceed 600mm. Where the space into which the boiler is going to be installed is less than the length of flue required the flue must be fitted from the outside.

### Installation from inside ONLY

b. If a core boring tool is to be used inside the building the space in which the boiler is to be installed must be at least wide enough to accommodate the tool.

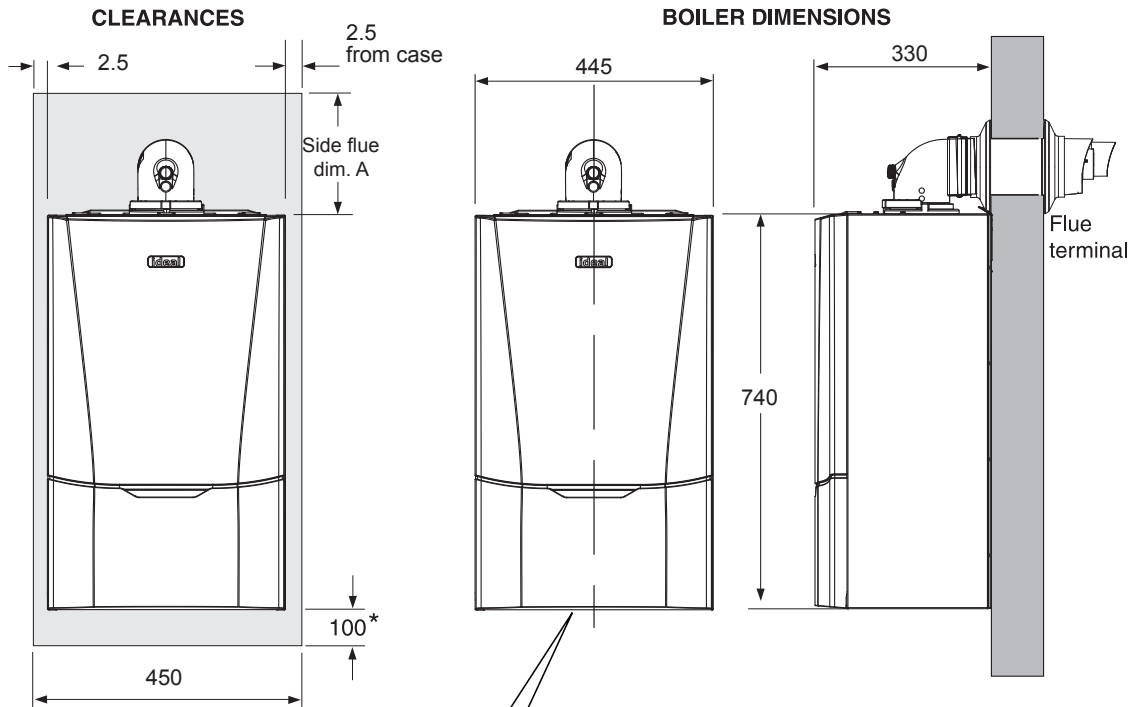

### Inset: Water Connections and Gas Connection

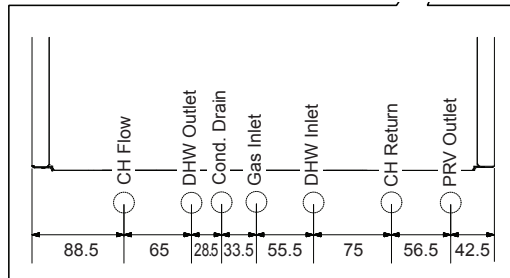

### Front clearance

The minimum front clearance when built in to a cupboard is 5mm from the cupboard door but 450mm overall clearance is still required, with the cupboard door open, to allow for servicing.

### \* Bottom clearance

Bottom clearance after installation can be reduced to 5mm. This must be obtained with an easily removable panel, to enable the consumer to access the filling loop, and to provide the 100mm clearance required for servicing.

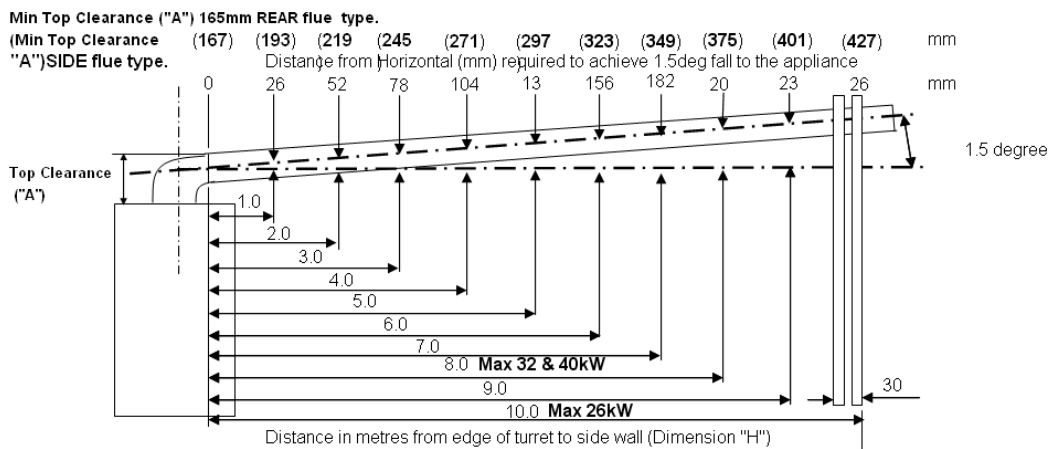

1. If the wall thickness is greater than 305mm then dimension "H" must be reduced by the difference in wall thickness.
2. For flue lengths requiring "D" pack extensions the flue must incline by 26mm per 1 Metre of flue length. No flue length greater than the maximum flue length shown above should be exceeded.

## SECTION 1 - GENERAL

### 1.18 SYSTEM REQUIREMENTS - Central Heating

#### Notes

- a. The method of filling, refilling, topping up or flushing sealed primary hot water circuits from the mains via a temporary hose connection is only allowed if acceptable to the local water authority.
- b. Antifreeze fluid, corrosion and scale inhibitor fluids suitable for use with boilers having stainless steel heat exchangers may be used in the central heating system.

#### General

1. The installation must comply with all relevant national and local regulations.
2. The installation should be designed to work with flow temperatures of up to 86 °C.
3. All components of the system must be suitable for a working pressure of 3 bar and temperature of 110 °C. Extra care should be taken in making all connections so that the risk of leakage is minimised.

The following components are incorporated within the appliance:

- a. Circulating pump.
  - b. Pressure relief valve, with a non-adjustable preset lift pressure of 3 bar.
  - c. Pressure gauge, covering a range of 0 to 4 bar.
  - d. A 10-litre expansion vessel, with an initial charge pressure of 0.75 bar.
4. **'Make-up' Water**

The water connection and isolation valves incorporate an approved system for filling and topping up the water in the heating system. Refer to Section 2.15 for details of how to fill and top up the system.

The maximum cold water capacity of the system should not exceed 159 litres, if not pressurized. However, if the system is to be pressurized, the efficiency of the expansion vessel will be reduced and a larger vessel (or smaller system volume) may be necessary. If the capacity of the vessel is not considered sufficient for this, or for any other reason, an additional vessel **MUST** be installed on the return to the boiler.

Guidance on vessel sizing is given in Table above.

#### 5. Filling

The system may be filled by the following method:

Where the mains pressure is excessive a pressure reducing valve must be used to facilitate filling.

<b>Pressure relief valve setting</b>	bar	3.0	
<b>Vessel charge pressure</b>	bar	0.5 to 0.75	
<b>System pre-charge pressure</b>	bar	None	1.0
<b>System volume (litres)</b>		<b>Expansion vessel volume (litres)</b>	
25		1.6	1.8
50		3.1	3.7
75		4.7	5.5
100		6.3	7.4
125		7.8	9.2
150		9.4	11.0
175		10.9	12.9
190		11.9	14.0
200		12.5	14.7
250		15.6	18.4
300		18.8	22.1
<b>For other system volumes multiply by the factor across</b>		0.063	0.074

<b>Model</b>		<b>26</b>	<b>32</b>	<b>40</b>
Max CH output	kW	18	26	32
Water flow rate @ 20°C differential	l/min	12.9	18.7	23
Head available for system	m.wg	4.6	2.9	2

- a. Thoroughly flush out the whole system with cold water.
- b. Fill and vent the system until the pressure gauge registers 1bar and examine for leaks. Refer to Section 2.15 for filling detail.
- c. Check the operation of the safety valve by raising the water pressure until the valve lifts. This should occur within 0.3bar of the preset lift pressure.
- d. Release water from the system until the minimum system design pressure is reached; 1.0 bar if the system is to be pre-pressurised.

*continued . . . . .*



**SYSTEM REQUIREMENTS - (CONTINUED)**

**DOMESTIC HOT WATER**

1. The domestic hot water service must be in accordance with BS 5546 and BS 6700.
2. Refer to Table 1 for minimum and maximum working pressures. In areas of low mains water pressures the domestic hot water regulator may be removed from the DHW flow turbine cartridge. Refer to Section 3.32. The boiler will require the flow rate to be set to obtain a temperature rise of 35°C at the tap furthest from the boiler.
3. The boilers are suitable for connection to most types of washing machine and dishwasher appliances.
4. If the shower/mixer valve does not incorporate non-return valves the following must be followed:
  - a. The cold inlet to the boiler is fitted with an approved anti-vacuum or syphon non-return valve.
  - b. Hot and cold water supplies to the shower are of equal pressure.

**5. Hard Water Areas**

Where the water hardness exceeds 200mg/litre (200ppm), it is recommended that a proprietary scale reducing device is fitted into the boiler cold supply within the requirements of the local water company.

**IMPORTANT.** Provision must be made to accommodate the expansion of DHW contained within the appliance. If the DHW inlet contains a back flow prevention device or non-return valve, e.g. a water meter, then a mini expansion vessel should be fitted between the device and the boiler in the cold inlet pipe.

Cold water, rising main & pipework in exposed areas need to be suitably lagged to prevent freezing.

**Note.** DHW Expansion Vessel kit available from Ideal.

**1.19 SYSTEM BALANCING**

The boiler does not normally need a bypass but at least some radiators on the heating circuit, of load of at least 10% of the minimum boiler output, must be provided with twin lockshield valves so that this minimum heating load is always available. See note regarding thermostatic radiator valves, refer to Section 1.14.

**Note.** Systems incorporating zone valves which could completely cut off the flow through the system must also include a bypass.

**BALANCING**

1. Set the programmer to ON.  
Close the manual or thermostatic valves on all radiators, leaving the twin lockshield valves (on the radiators referred to above) in the OPEN position. Turn up the room thermostat and adjust the lockshield valve to give an uninterrupted flow through the radiator. These valves should now be left as set.
2. Open all manual or thermostatic radiator valves and adjust the lockshield valves on the remaining radiators, to give around 20°C temperature drop at each radiator.
3. Adjust the room thermostat and programmer to NORMAL settings.

**1.20 WATER TREATMENT**

**CENTRAL HEATING**

The Vogue Combi GEN2 range of boilers have a stainless steel heat exchanger.

**IMPORTANT.**

**The application of any other treatment to this product may render the guarantee of Ideal Heating Invalid.**

**Ideal Heating** recommend Water Treatment in accordance with the Benchmark Guidance Notes on Water Treatment in Central Heating Systems.

If water treatment is used **Ideal Heating** recommend only the use of SCALEMASTER SM-1 PRO, FERNOX, MBI, ADEY MC1 or SENTINEL X100 inhibitors and associated water treatment products, which must be used in accordance with the manufacturers' instructions.

**Notes.**

1. *It is most important that the correct concentration of the water treatment products is maintained in accordance with the manufacturers' instructions.*
2. *If the boiler is installed in an existing system any unsuitable additives MUST be removed by thorough cleansing. BS 7593 details the steps necessary to clean a domestic heating system.*
3. *In hard water areas, treatment to prevent limescale may be necessary - the use of artificially softened water is permitted when filling the system, where the cold supply is fitted with a water softening device.*
4. *Under no circumstances should the boiler be fired before the system has been thoroughly flushed.*

**DOMESTIC HOT WATER**

In hard water areas where mains water can exceed 200ppm Total Hardness (as defined by BS 7593 Table 2) a scale reducing device should be fitted into the boiler cold supply within the requirements of the local water company.

Water softener SHOULD be used in the event that the installation site has a water hardness above 154 ppm (9 gpg). In any case, the cold supply to the boiler should be within the constraints listed below;

	<b>Max</b>	<b>Min</b>
Water Hardness (WH)	154 ppm (9 gpg)	80 ppm (4.7 gpg)
pH Value	8.5	6.0

**Ideal Heating** recommend the use of Fernox Quantomat, Sentinel Combiguard and Calmag CalPhos I scale reducing devices or Scalemaster Inline Scale Inhibitor branded Ideal, which must be used in accordance with the manufacturers' instructions.

For further information contact:

**Fernox Cookson Electronics**

Forsyth Road, Sheerwater, Woking, Surrey GU21 5RZ  
+44 (0) 8706 015000

**Sentinel Performance Solutions**

The Heath Business & Technical Park, Runcorn, Cheshire WA7 4QX  
Tel: 0800 389 4670

**Scalemaster Water Treatment Products**

Emerald Way, Stone, Staffordshire ST15 0SR  
Tel: +44 (0) 1785 811636

**Calmag Ltd.**

Unit 3-6, Crown Works, Bradford Road, Sandbeds, Keighley, West Yorkshire BD20 5LN  
Tel: +44 (0) 1535 210320

**Adey Professional Heating Solutions**

Gloucester Road, Cheltenham GL51 8NR  
Tel: +44 (0) 1242 546700

## SECTION 2 - INSTALLATION

### 2.1 BOILER ASSEMBLY - Exploded View

**Note** that item numbers are linked to the spares list

- 104 CH Return Valve
- 105 CH Flow Valve
- 106 DHW Valve
- 107 Filling Loop
- 108 Pump Head
- 110 Air Vent
- 111 Diverter Valve Head
- 112 Diverter Valve Cartridge
- 113 Pressure Relief Valve
- 114 Pipe - PRV Outlet
- 115 Pipe - Flow
- 116 Pipe - Return
- 117 Pipe - Expansion Vessel

- 118 Expansion Vessel
- 119 Return Group Manifold
- 120 Flow Group Manifold
- 121 Plate Heat Exchanger
- 123 Flow Sensor Hall Effect
- 124 Flow Turbine Cartridge
- 125 Water Pressure Switch
- 127 Pressure Gauge
- 203 Pipe - Gas Inlet
- 204 Gas Valve
- 205 Injector - Gas
- 207 Venturi
- 208 Fan

- 209 Gasket - Fan/Venturi
- 210 Fan Adaptor
- 211 Venturi Deflector
- 212 Condensate Hose
- 213 Flue Turret Clamp
- 214 Siphon trap
- 218 Flue Manifold
- 219 Flue Manifold Seal
- 220 Fan Adaptor Seal
- 302 Primary PCB
- 303 CUI Board
- 304 Thermistor (Flow & Return)
- 306 Electrode Ignition

- 307 Electrode Detection
- 308 Ignitor Unit
- 317 Control Box Front
- 318 Control Box Lid
- 319 Programmer Blank Insert
- 321 Control Box Hinges
- 401 Heat Engine
- 403 Heat Engine Gasket
- 404 Burner Door
- 501 Front Panel/Door
- 503 Wall Mounting Plate
- 504 Bracket - Ignition

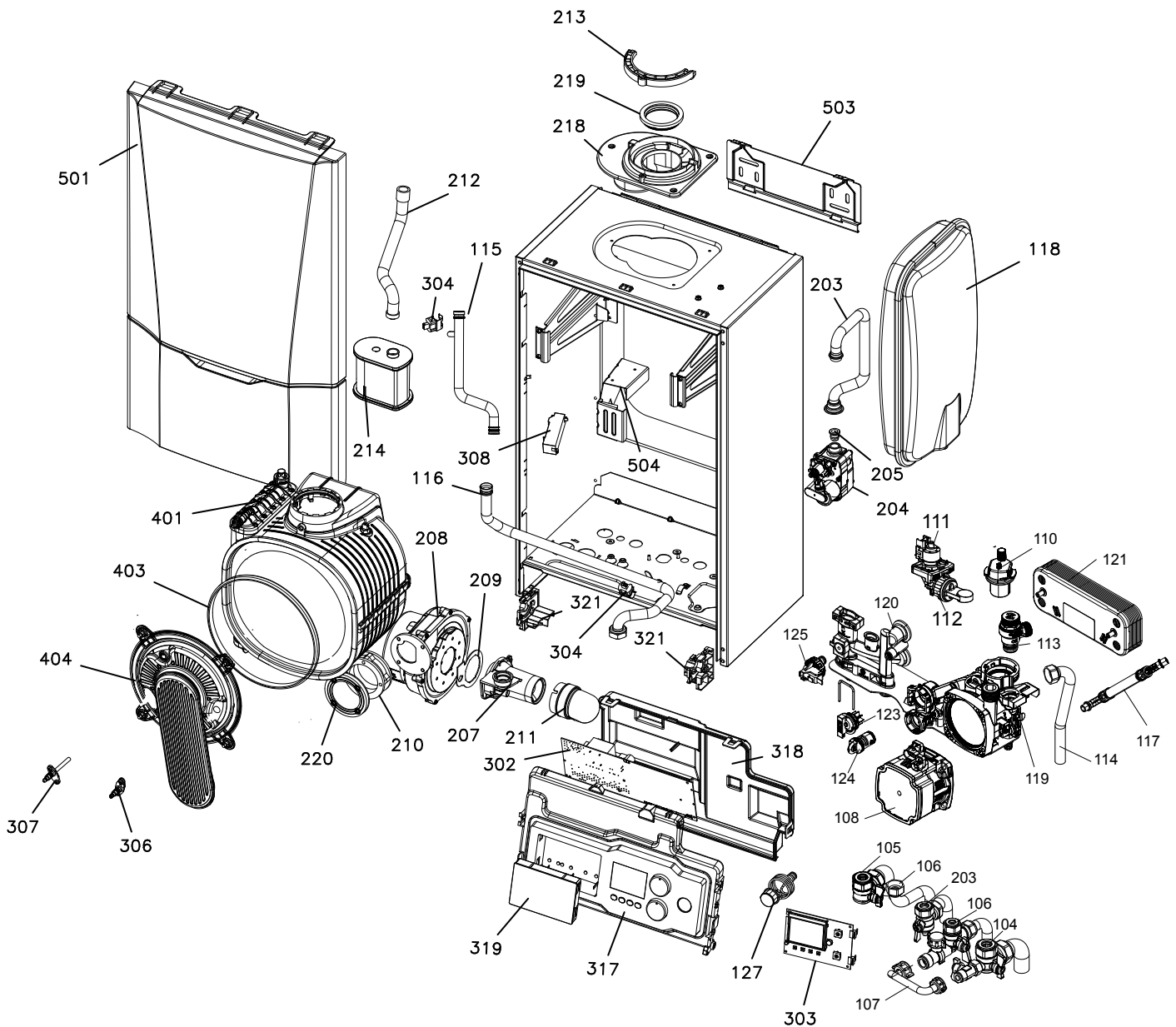

**Model shown - 40**

## SECTION 2 - INSTALLATION

### 2.2 UNPACKING

The boiler is supplied fully assembled in Pack A. A telescopic or non-telescopic flue assembly for rear or side flue outlet, in Pack B is supplied as a separate order.

**Unpack and check the contents.**

#### Pack A Contents

- A Boiler
- B Hardware Pack Box
- C Wall Mounting Plate
- D These Installation Instructions
- E Wall Mounting Template (located on internal protective packaging)
- F Turret Clamp
- G Pressure Relief Valve Drain Pipe
- H Boiler Guarantee & Registration Pack

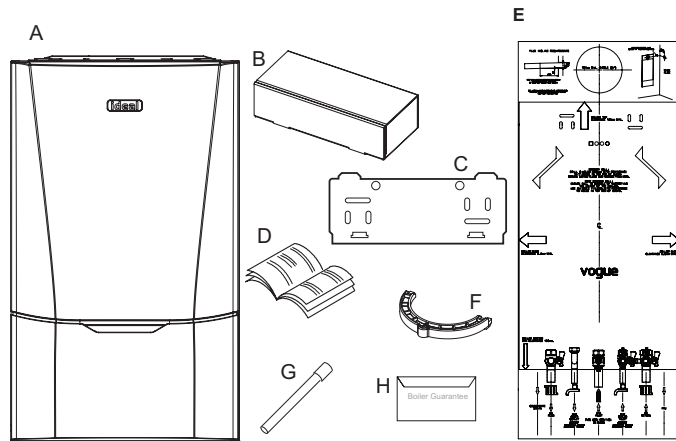

#### HARDWARE PACK CONTENTS

##### Gas Valve Pack

1. Pipe - Gas Inlet
2. Washer - Gas (blue)
3. Gas Cock

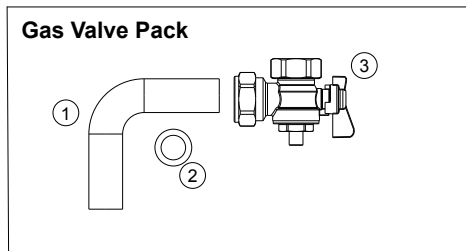

##### Filling Loop Pack

1. 3/8" Top Hat Washer
2. Valve Filling Loop
3. Pipe Filling Loop
4. Washer Fibre 3/8"

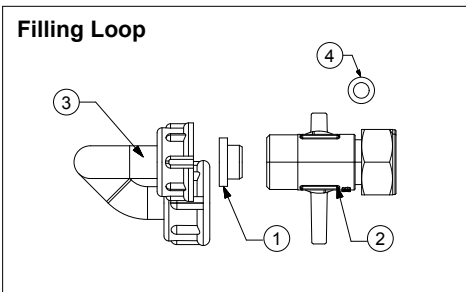

##### Return Valve Pack

1. Pipe CH Return
2. Washer CH
3. Valve Return

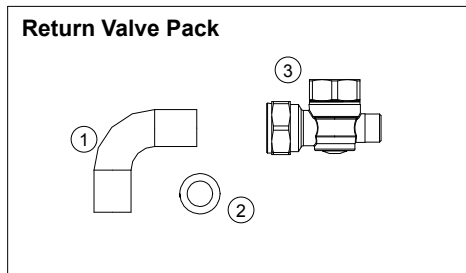

##### DHW Pack

1. 1/2" Top Hat Washer (x2)
2. Cap Female
3. Plug Male and Clip
4. Nut G1/2 16 Brass (Flat)
5. Washer 18.5 x 11 x 11.8 (x2)
6. Pipe DHW Outlet
7. Pipe DHW Inlet
8. Valve DHW Inlet

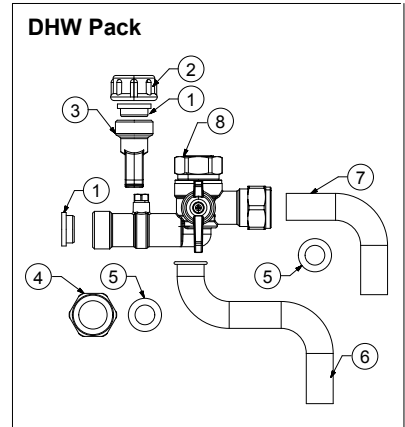

##### Accessory Pack

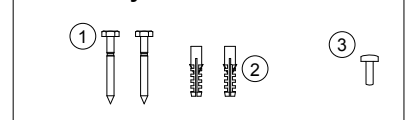

##### Accessory Pack

1. Screw (x2)
2. Wallplug (x2)
3. Turret Clamp Screw (spare)

##### Flow Valve Pack

1. Pipe CH Flow
2. Washer CH
3. Valve Flow

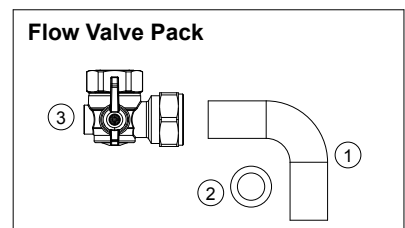

continued . . . . .

## UNPACKING CONT'D

**Note.** This flue system incorporates a removable flue outlet nose that utilises a push fit location system. This enables the installation of deflector, high level or balcony outlet flue kits without the removal of the whole 'B' pack terminal. The appliance must not be operated without the desired outlet nose correctly fitted in place.

*Note.* Location dimples must be aligned with terminal mounting frame.

### Pack B Contents Telescopic

- A Telescopic Flue Terminal
- B Flue Turret
- C Rubber Terminal Wall Seal (external)
- D Screw
- E Sealing Tape
- F Wall Seal - White (internal)

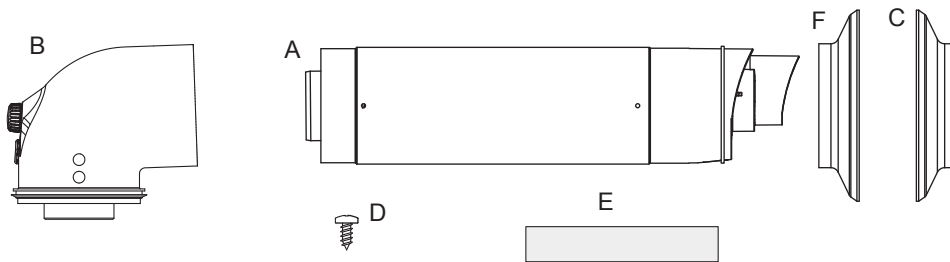

### Pack B Contents Non-Telescopic

- A Flue Terminal
- B Flue Turret
- C Rubber Terminal Wall Seal (external)
- D Cutting Aid
- E Wall Seal - White (internal)

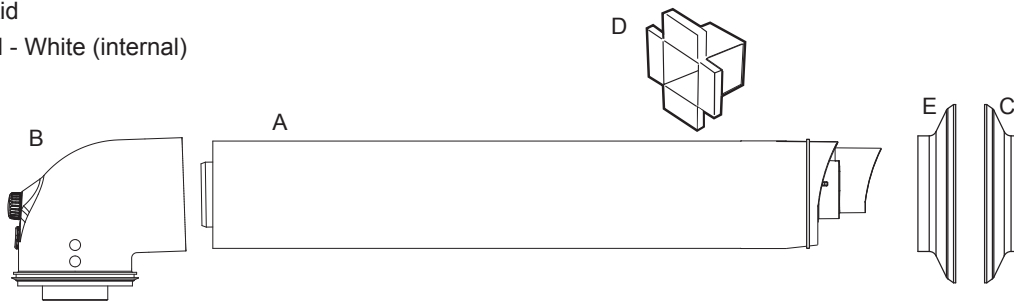

## 2.3 FRONT PANEL REMOVAL

1. Loosen the 2 screws retaining the front panel.
2. Pull the two clips downwards to disengage.
3. Pull the front panel forward and upwards to remove.

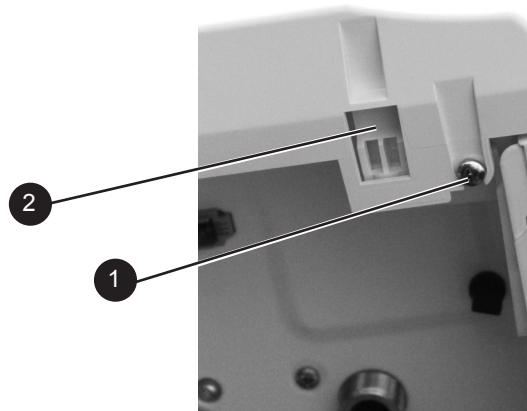

## SECTION 2 - INSTALLATION

### 2.4 WALL MOUNTING TEMPLATE

The wall mounting template is located on the internal protective packaging. The template shows the position of the fixing and rear flue centre holes for a standard installation

*Care MUST be taken to ensure the correct holes are drilled.*

1. Tape template into the required position, ensuring its squareness by hanging a plumbline as shown.
2. If fitting a side flue, extend the flue centreline onto the side by **131mm** on a standard wall fix or **176mm** if using a stand-off bracket.
3. Mark the following on to the wall:
  - a. The selected group of wall mounting screw holes.
  - b. The centre position of the flue duct. Marking both the centre and the circumference of the flue duct.
4. Remove the template plate from the wall.

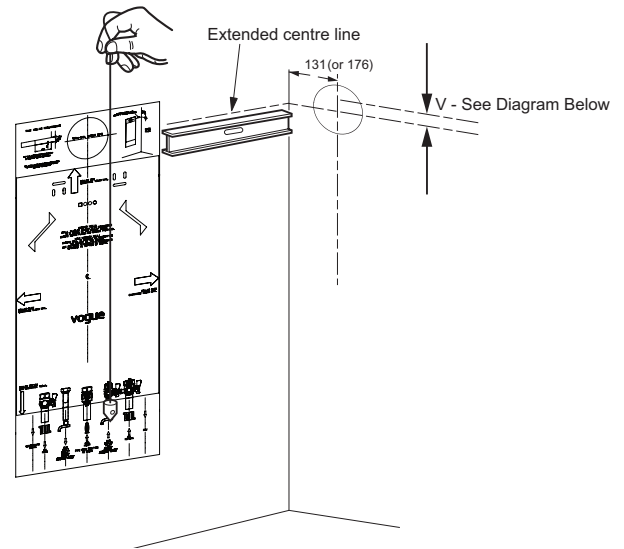

### 2.5 PREPARING THE WALL

#### IMPORTANT.

Ensure that, during the cutting operation, masonry falling outside of the building does not cause damage or personal injury.

1. Cut the flue hole (preferably with a 5" core boring tool), ensuring that the hole is square to the wall. Both wall faces immediately around the cut hole should be flat.
2. Drill 2 mounting holes (marked from template) with a 7.5mm / 8mm masonry drill and insert the plastic plugs, provided, for the wall mounting plate.
3. Locate 2 No.14 x 50mm screws in the wall mounting plate (one at each side, in any of the 3 holes provided at each side) and screw home. Ensure mounting bracket is level.

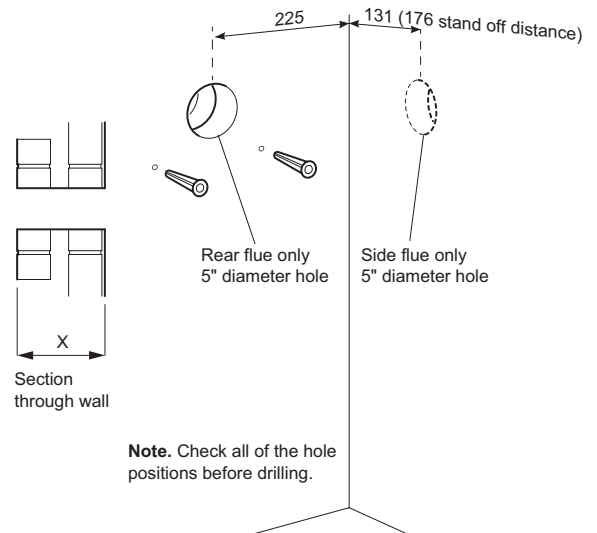

### 2.6 FITTING THE WALL MOUNTING PLATE

Screw the wall mounting plate to the wall using 2 wall plugs (previously fitted) with the 2 screws provided.

Choose one of the 2 sets of slots in left and right bank. Ensuring that at least one of the screws is fitted into a top slot and the mounting bracket is level.

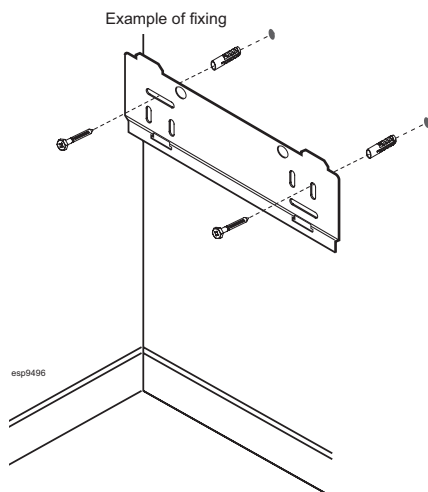

### 2.7 MOUNTING THE BOILER

1. Ensure the plastic plugs are removed from both the CH and DHW connections before mounting the boiler.

*Note. boiler may contain residual water.*

2. Lift the boiler onto the wall mounting plate (refer to the Introduction section for safe handling advice), locating it over the two tabs.

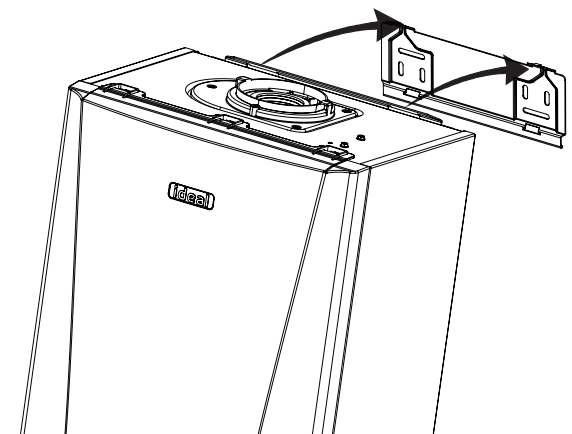

## SECTION 2 - INSTALLATION

### 2.8 DETERMINING THE FLUE LENGTH AND FLUE PACKS REQUIRED

IMPORTANT. The boiler must be installed in a vertical position in accordance to the installation instructions.

#### FLUE KITS

**Telescopic Flue 'B' Pack** - contains: Flue turret, telescopic flue incorporating a terminal, rubber wall seal and instructions

**Horizontal Flue Terminal (600mm long) 'B' Pack** - contains: Flue turret, non telescopic single piece flue incorporating a terminal, rubber wall seal and instructions.

**Horizontal Flue Terminal (1000mm long) 'B' Pack** - Flue turret, telescopic flue incorporating a terminal, rubber wall seal and instructions.

*Note. If 'B' packs are used on their own (either 1 piece or telescopic), then they can be fitted horizontally as the flue inside is designed to slope 1.5 degrees.*

**'D' Pack** - contains: 1 metre length of flue pipe (Functional length 950mm), 1 support bracket and instructions.

*When extension 'D' Packs are used the flue duct must incline 1.5 degrees away from the appliance, to allow the condensate to drain back to the boiler and out of the condensate drain. It is recommended that a support bracket is fitted on every 1 metre of pipe work used and the bracket is located as close to the collar as possible. The bracketing must ensure a 1.5 degree fall back to the appliance.*

**Optional Flue Finishing Kit** - Concentric Flue Screw Retaining Kit (Optional Kit of mechanical fixing of flue joints)

Only use water as a lubricant during assembly.

The 'B' pack terminal is classed as part of the maximum flue length.

This flue system incorporates a removable flue outlet nose that utilises a push fit location system. This enables the installation of deflector, high level or balcony flue kits without the removal of the whole 'B' pack terminal. The appliance must not be operated without the desired outlet nose correctly fitted in place, ensuring the side location dimples are in line with the mounting face allowing the correct sealing of the components.

It is IMPORTANT that all attachments are fitted in accordance to the installation instructions provided with them.

The TURRET supplied in the 'B' Pack has an upper combustion sample point with a screw cap seal and a lower air sample point with an air stopper seal. Ensure all caps & seals are in place.

**Additional Termination Kits** available for use with these 'B' packs.

Flue Deflector Kit	The resistance is the equivalent of 1 metre of flue pipe and therefore must be deducted from any maximum flue length
High Level Flue Outlet Kit	The maximum permissible concentric flue length when using a standard (500mm) kit is 4.5 metres
Balcony Flue Outlet Kit	The maximum permissible concentric flue length when using this kit is dependant on the length of the balcony flue outlet run which combined with the concentric run must not exceed the maximum flue length requirement of the appliance it is to be fitted to

**Total Maximum Permissible Horizontal Concentric Flue Length** combining both 'B' Packs and 'D' Packs  
(Measured from centreline of the turret to the outside of the wall terminal)

26 kW appliances	Total Maximum: 10 metres - minus any flue kit options or bends
32 & 40kW Appliances	Total Maximum: 8 metres - minus any flue kit options or bends

**Total Maximum permissible Vertical Flue Length** combining both Roof Terminal and 'D' Packs

26, 32 & 40kW Appliances	Total Maximum: 10 Metres - minus any bends
--------------------------	--

**90° Elbow Kit 60/100** - (Equivalent flue length resistance = **1M**)

**45° Elbow Kit 60/100** - (Equivalent flue length resistance = **0.6M**)

**Minimum Horizontal Flue Lengths** (Centre line of turret to outside of wall terminal)

Telescopic terminal = 350mm

One piece terminal = 285mm

#### Wall Thickness

Std Metric Brick 102.5mm wide

'B' Pack Flue Type	Minimum permissible Wall Thickness			Maximum permissible Wall Thickness		
	Rear Flue	Rear Flue + Std-Off	Side Flue	Rear Flue	Rear Flue + Std-Off	Side Flue
Horizontal Flue Terminal (600mm long) B Pack	154	102.5	102.5	513	482	433
Telescopic Flue B Pack	265	220	171	464	433	384
Horizontal Flue Terminal (1000mm long) B Pack	577	532	483	780	749	700
Horizontal Flue Terminal (1000mm long) B Pack cut 75mm	522	457	498	705	674	625

**For Flue lengths between 658 & 708 use a Horizontal Flue Terminal (1000mm long) B Pack, cut 75mm off the end of the terminal section of the telescopic flue only.**

## SECTION 2 - INSTALLATION

### DETERMINING THE FLUE LENGTH AND FLUE PACKS REQUIRED, CONT'D

**FIGURE 1**

Note. Maximum permissible flue length is measured from centre line of appliance flue outlet to outside wall face.

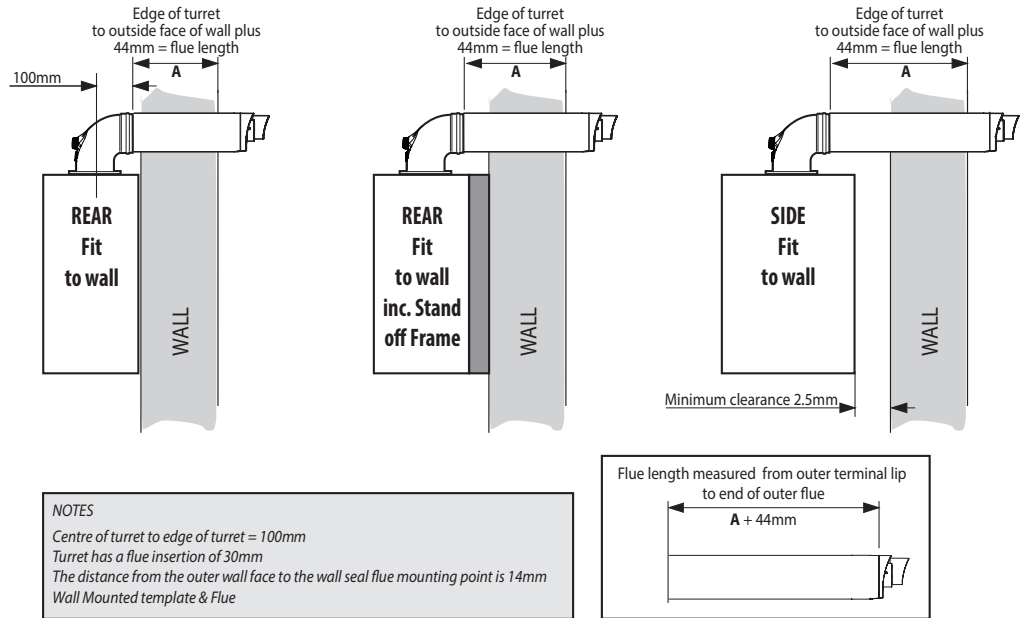

**FIGURE 2**

Actual maximum flue length requirements  
(outside edge of turret to out side face of wall plus 44mm (Cut Length))

	Minimum & Maximum finished flue lengths obtainable (dimension 'A' +44mm)								Max output 32 & 40 kW Max output 26 kW
	Horizontal Flue Terminal (600mm long) B Pack		Telescopic Flue B Pack		Horizontal Flue Terminal (1000mm long) B Pack (Telescopic)		Horizontal Flue Terminal (1000mm long) B Pack (Telescopic) Cut 75mm		
	Minimum	Maximum	Minimum	Maximum	Minimum	Maximum	Minimum	Maximum	
<b>B Pack (Standard)</b>	233	602	340	553	652	869	577	794	
Plus 1 (1m D pack)	1183	1552	1290	1503	1602	1819	1527	1744	
Plus 2 (1m D pack)	2133	2502	2240	2453	2552	2769	2477	2694	
Plus 3 (1m D pack)	3083	3452	3190	3403	3502	3719	3427	3644	
Plus 4 (1m D pack)	4033	4402	4140	4353	4452	4669	4377	4594	
Plus 5 (1m D pack)	4983	5352	5090	5303	5402	5619	5327	5544	
Plus 6 (1m D pack)	5933	6302	6040	6253	6352	6569	6277	6494	
Plus 7 (1m D pack)	6883	7252	6990	7203	7302	7519	7227	7444	
Plus 8 (1m D pack)	7833	8202	7940	8153	8252	8469	8177	8394	
Plus 9 (1m D pack)	8783	9152	8890	9103	9202	9419	9127	9344	
Plus 10 (1m D pack)	9733	N/A	9840	10000	N/A	N/A	N/A	N/A	

Note; Telescopic flue B Pack or attached "D" pack extensions do not need to be cut between minimum and maximum values shown above (except where specified). Horizontal Flue Terminal (600mm long) B Pack flue will require cutting on values below maximum values shown above.

## 2.9 CUTTING & SETTING THE FLUE LENGTH

### TELESCOPIC FLUES

**TELESCOPIC FLUE B PACK** SHOULD ONLY BE ADJUSTED FOR USE WITHIN ITS SPECIFIED RANGE AND MUST NOT BE CUT

**HORIZONTAL FLUE TERMINAL (1000MM LONG) B PACK (TELESCOPIC)** MUST ONLY BE CUT IF REQUIRED FLUE LENGTHS ARE BETWEEN **602 & 652MM**. THIS WILL REQUIRE 75MM TO BE CUT OFF THE TERMINAL END OF THE 1000MM TELESCOPIC FLUE.

ALL OTHER LENGTHS OBTAINED USING "D" PACK EXTENSIONS IN FLUE LENGTH TABLE 1, COLUMN "HORIZONTAL FLUE TERMINAL (1000MM LONG) B PACK CUT 75MM" (TELESCOPIC) SHOULD HAVE THE 75MM CUT OFF THE "D" PACK EXTENSION AND NOT TELESCOPIC FLUE

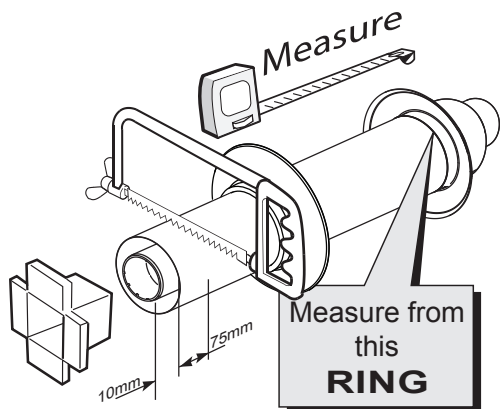

### CUT 75MM OFF HORIZONTAL FLUE TERMINAL 1000MM LONG B PACK (TELESCOPIC)

1. Measure cut flue length ( $A+44\text{mm}$ ). (If required telescopic length is not between 658 and 708 then proceed to set flue 7b).
2. Remove telescopic end piece from the flue body and set aside.
3. Mark the circumference 75mm from the open end of the outer flue.
4. Cut along the 75mm mark cutting **only the outer flue** ensuring the cut is square.
5. Dress the cut end to make sure all burr is removed and the cut edge is in its original shape.
6. Measure 20mm from the newly cut edge of the outer flue, place a mark at the top of the flue approximately 20mm wide & write stop the terminal side of the line.
7. Mark the inner tube 10mm longer than the outer tube around its circumference and cut following the mark to ensure its cut square
8. Remove all burrs and place a chamfer on the outer edge to aid assembly.
9. Re-assemble telescopic section.

### SETTING TELESCOPIC FLUE B PACK

1. Measure the required flue length ( $A+44\text{mm}$ ).
2. Measure from the outer terminal lip to end of outer flue. Pull apart flue until desired length is achieved. **ENSURE THE STOP MARK IS NOT VISIBLE, IF IT IS, THE FLUE IS TOO SHORT AND SHOULD NOT BE USED.**
3. Check that both flue seams are at the top and the outlet terminal is upper most.
4. Drill a 3.5mm hole through one of the 2 outer side holes into the inserted outer flue. Take care not to pierce the inner plastic flue.
5. Seal the joint on the outer air duct with the tape provided.
6. Fit internal and external wall seals (see installing flue)

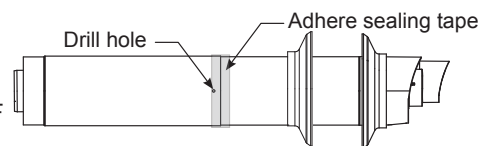

### CUTTING HORIZONTAL FLUE TERMINAL (600MM LONG) B PACK

1. Measure the required cut flue length ( $A+44\text{mm}$ ). If inside the dimensions shown in Figure 2 "1 Piece 600mm" proceed.
2. Measure from the outer terminal lip to end of outer flue. Mark the required cut length ( $A+44$ ) around the circumference of the outer flue and cut following the mark to ensure it is cut square.
3. Dress the cut end to make sure all burrs are removed and the cut edge is in its original shape.
4. Mark the inner tube 10mm longer than the outer tube around its circumference and cut following the mark to ensure it is cut square.
5. Remove all burrs and place a light chamfer on the outer edge to aid assembly.

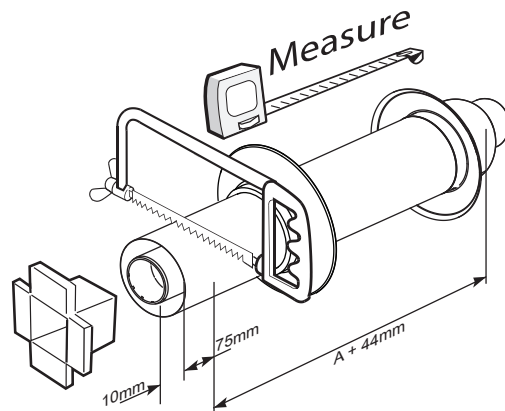



## 2.10 INSTALLING THE FLUE

### FITTING FLUE THROUGH THE WALL

1. Measure wall thickness and add 14mm.
2. Measure from the outer terminal lip towards outer flue, place a small location mark at the dimension acquired at point 1.
3. Add a further 14mm to the dimension, obtain at item 1 and place an additional small location mark.
4. Fit external black wall seal ensuring the outer lip is in contact with the lip you have been measuring from (see fig 1)
5. Fit the internal wall seal approximately 65mm before the outer of the 2 location marks.
6. For an internal fit place flue terminal in the centre of the 5" drilled hole in the wall. Apply pressure and lightly move the flue left to right or up and down. This will cause the outer flange to fold in and allow the flue to pass through the wall.
7. Push through a further 65mm or until the inner flange is pressed against the inner wall. This will allow the outer flange to return to its original shape.
8. Pull back the flue until the first of the 2 location marks re level with the internal face of the wall.

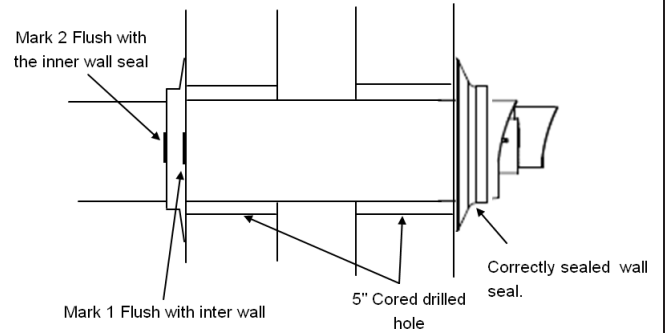
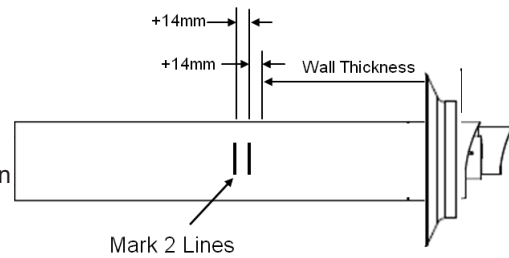

*Note. If the 2 location marks are not visible then the flue is not pulled back far enough to obtain the correct seal. If the 1st location mark has passed the face of the wall the flue has been pulled too far back and the outer wall seal will have been dislodged from its mounting and will need to be refitted.*

9. When 1st mark is in line with the wall, whilst holding the flue firmly, push the white wall sealing flange to the wall until the 2nd of the two marks is just visible. If the last location mark is clearly passed the white inner wall seal then the outer wall seal will have been dislodged from its mounting and will need to be re-fitted.
10. Ensure the seam and the outlet terminal are at the top and fitted as shown.

*Note. If less than 50% of the length of the flue is internal the flue should be fitted from outside.*

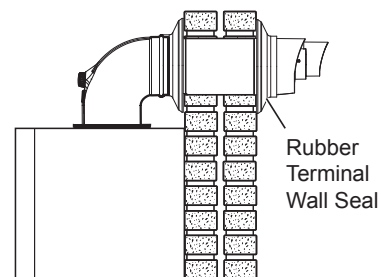
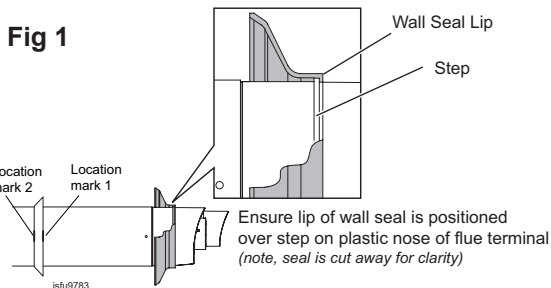

### FITTING THE TURRET

1. Ensure the rubber seal is fitted correctly on the appliance manifold and that all flue seals are undamaged.
2. Hold the flue firmly and push the turret on until it has travelled 30mm on to the flue pipe and is fully engaged. Make sure the flue has not rotated or moved forward during fitting and the flue seam is upper most.
3. Push the turret into the manifold ensuring the upper plastic lip is flush with the top of the manifold.
4. Fully engage the clamp location section into the manifold location holes. Rotate down on to turret flange.
5. Secure clamp to appliance using securing screw.
6. Ensure all sample points are accessible and all sample plugs and caps are fitted.

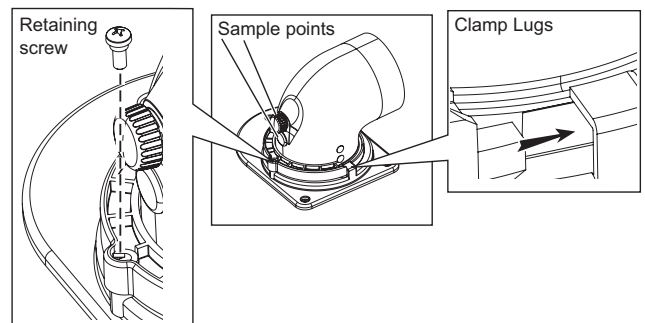
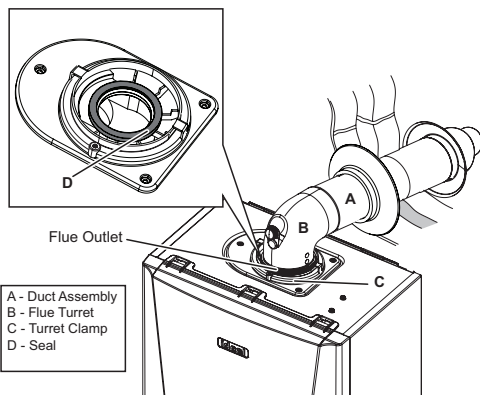

## 2.11 CONDENSATE DRAIN

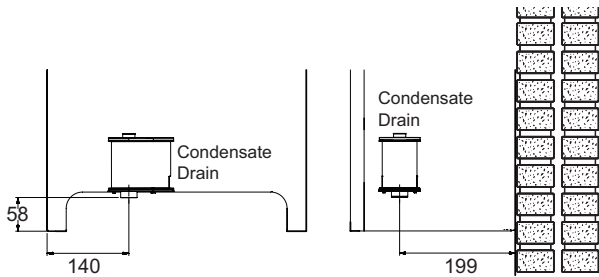

This appliance is fitted with a siphonic 75mm condensate trap system that requires filling before operating the appliance for the 1st time or after maintenance.

All condensate pipework should conform to the following:

- a. Where a new or replacement boiler is being installed, access to an internal 'gravity discharge' termination should be one of the main factors considered in determining boiler location.
- b. Plastic with push fit or solvent connections.
- c. Internal plastic pipe work a minimum of 19mm ID (typically 22mm OD)
- d. External plastic pipe must be a minimum of 30mm ID (typically 32 OD) before it passes through the sleeved wall.
- e. All horizontal pipe runs, must fall a minimum of 45mm per metre away from the Boiler.
- f. External & unheated pipe work should be kept to a minimum and insulated with Class "O" waterproof pipe insulation.
- g. All installations must be carried out in accordance to the relevant connection methods as shown in the "Condensate installation diagrams" & BS6798.
- h. Pipe work must be installed so that it does not allow spillage into the dwelling in the event of a blockage (through freezing)
- i. All internal burrs should be removed from the pipe work and any fittings.

In order to minimise the risk of freezing during prolonged very cold spells, one of the following methods of terminating condensate drainage pipe should be adopted.

### Internal Drain Connections

Wherever possible, the condensate drainage pipe should be routed to drain by gravity to a suitable internal foul water discharge point such as an internal soil and vent stack or kitchen or bathroom waste pipe etc. See Figs 1 and 2.

**Note.** For installations where the PRV is required to terminate into the Condensate Drain Pipe, a proprietary termination and back flow prevention kit **MUST** be purchased separately from a plumbers merchant. The installation instructions for the kit **MUST** be followed.

**Figure 1 - Connection of Condensate Drainage Pipe to Internal Soil & Vent Stack**

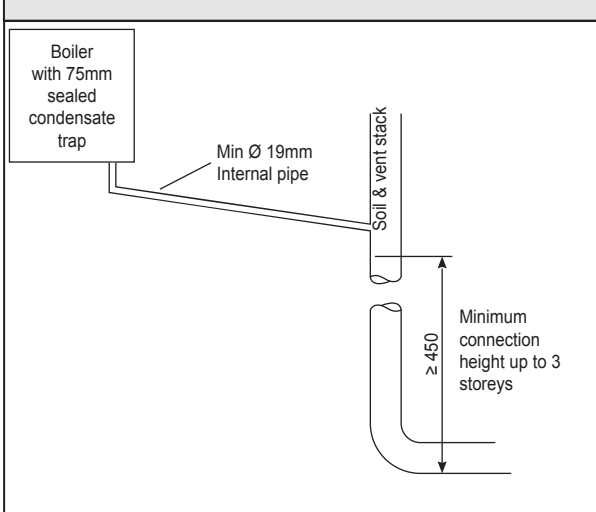

### Condensate Pump

Where gravity discharge to an internal termination is not physically possible or where very long internal pipe runs would be required to reach a suitable discharge point, a condensate pump of a specification recommended by the boiler or pump manufacturer should be used terminating into a suitable internal foul water discharge point such as an internal soil and vent stack or internal kitchen or bathroom waste pipe etc. (fig 3).

### External Drain Connections

The use of an externally run condensate drainage pipe should only be considered after exhausting all internal termination options as described previously. An external system must terminate at a suitable foul water discharge point or purpose designed soak away. If an external system is chosen then the following measures must be adopted:

The external pipe run should be kept to a minimum using the most direct and "most vertical" route possible to the discharge point, with no horizontal sections in which condensate might collect.

- For connections to an external soil/vent stack see Fig 4. Insulation measures as described should be used.
- When a rainwater downpipe is used, an air break must be installed between the condensate drainage pipe and the downpipe to avoid reverse flow of rainwater into the boiler should the downpipe become flooded or frozen, see Fig 5.
- Where the condensate drain pipe terminates in a purpose designed soak away (see BS 6798) any above ground condensate drain pipe sections should be run and insulated as described above. See Fig 6.
- Where the condensate drain pipe terminates over an open foul drain or gully, the pipe should terminate below the grating level, but above water level, to minimise "wind chill" at the open end. The use of a drain cover (as used to prevent blockage by leaves) may offer further prevention from wind chill.

### Unheated Internal Areas

Internal condensate drain pipes run in unheated areas, e.g. lofts basements and garages, should be treated as external pipe.

Ensure the customer is aware of the effects created by a frozen condensate and is shown where this information can be found in the user manual.

**Figure 2 - Connection of a Condensate Drainage Pipe Downstream of a Sink, Basin, Bath or Shower Water Trap to Internal Soil Vent Stack**

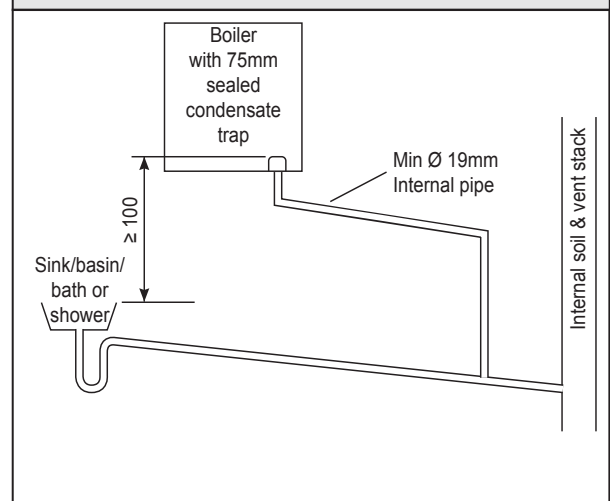

continued . . . . .

## SECTION 2 - INSTALLATION

### CONDENSATE DRAIN - CONT'D.....

**Figure 3** - Connection of a Condensate Pump Typical Method (see manufacturer's detailed instructions)

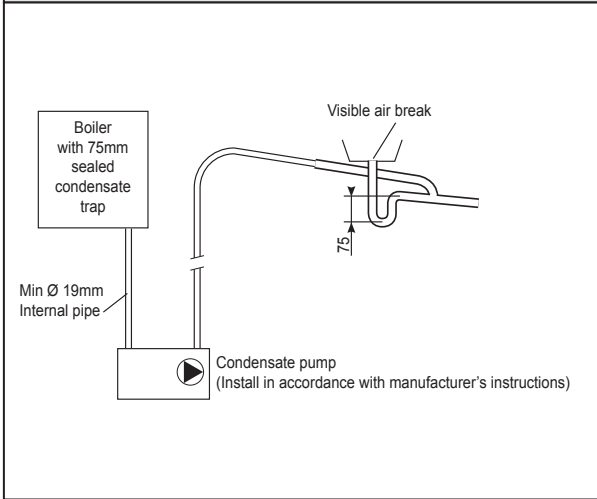

**Figure 4** - Connection of condensate Drainage Pipe to External Soil & Vent Stack

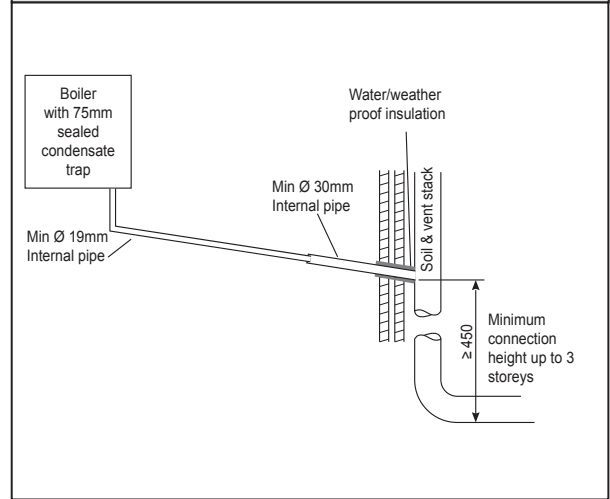

**Figure 5** - Connection of a Condensate Drainage Pipe to an External Rainwater Downpipe (only combined foul/rainwater drain)

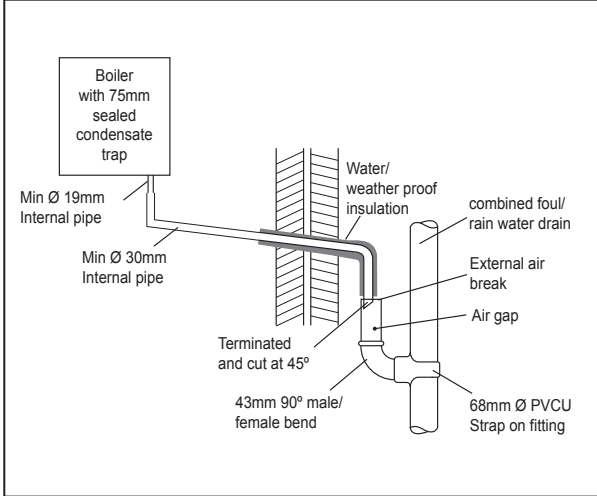

**Figure 6** - Connection of a Condensate Drainage Pipe to an External Purpose Made Soak Away.

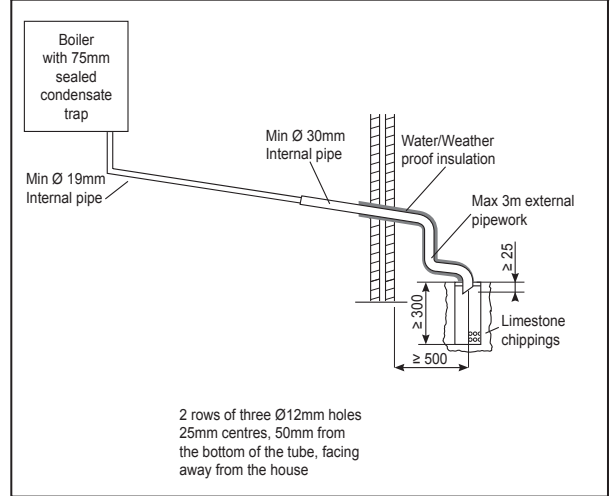

### 2.12 FITTING THE OPTIONAL ROOF FLUE KIT (Flat or Pitched)

**Note.**

*A flat or pitched roof flashing plate (not supplied) is required before proceeding with the installation of this kit.*

This kit is suitable for both flat and pitched roof terminations, using a concentric flue to run vertically from the top of the boiler and terminating above roof level.

**Connection to the top of the boiler is made using a separately supplied vertical connector.**

**WEATHER PROOFING**

Where the flue passes through the roof line an adequate seal must be made. This is achieved by using either:

- Flat roof weather collar
- or
- Universal weather collar.

**ACCESSORIES**

Flue Duct Extension Kits are available for flue lengths extending beyond 1m. These packs contain 1m extension ducts and may be cut to the desired length.

If the offset vertical option is used an elbow Kit is required.

Please visit [idealheating.com](http://idealheating.com) to access the Flue and Accessories Guide for this boiler.

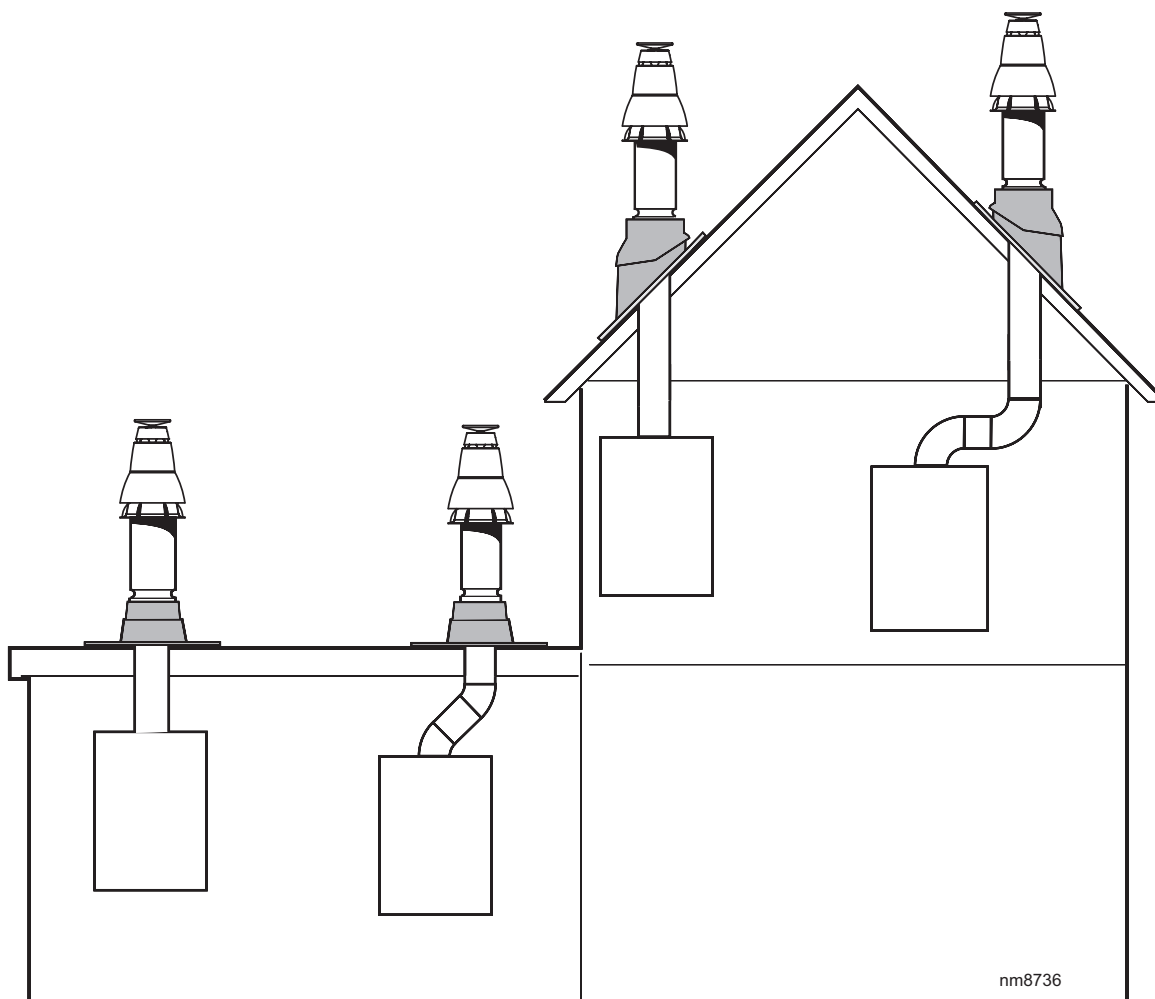

## SECTION 2 - INSTALLATION

### 2.13 FLUE TERMINAL POSITION

The terminal should be positioned so that products of combustion can safely disperse at all times.

Plumbing may occur at the termination so, where possible, terminal positions where this could cause a nuisance should be avoided.

Minimum dimensions are shown below

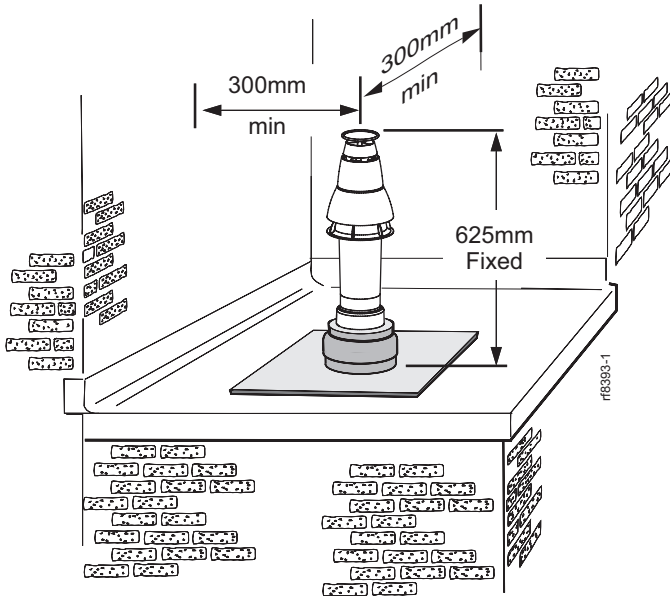

Flat roof - with structure

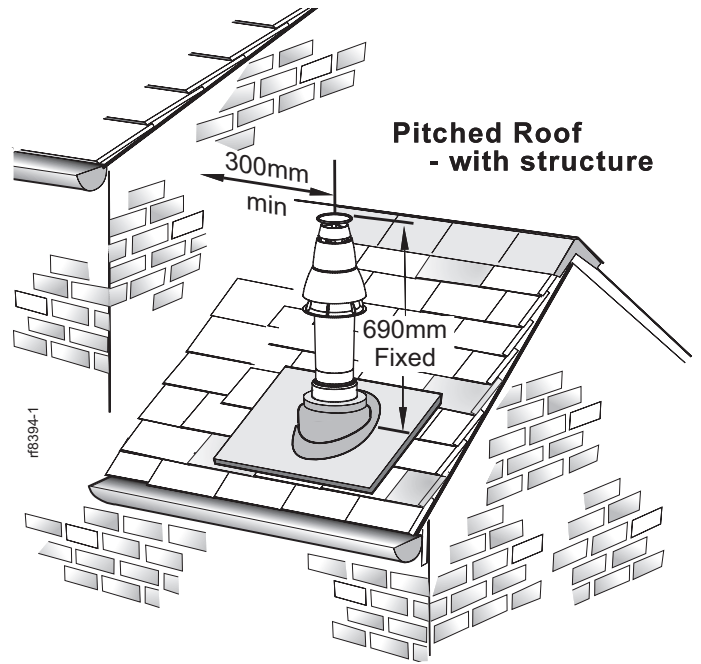

Pitched Roof - with structure

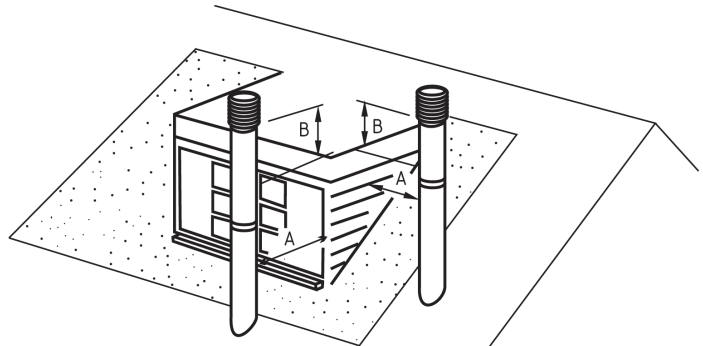

If chimney penetrates dotted area such that A is less than 300mm, B shall not be less than 300mm.

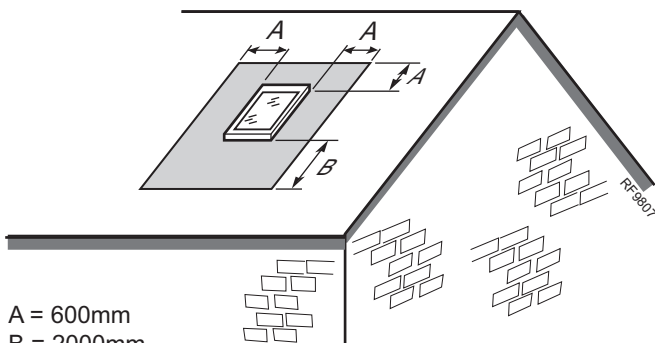

A = 600mm  
B = 2000mm

The flue terminal shall not penetrate the shaded area of the roof

**Pitched roof - with velux window or opening**

Where two or more vertical fanned draught chimney configurations terminate in close proximity at the same height, they shall be separated by at least 300mm. Where any one vertical outlet is more than 300mm above the other, then they shall be separated by at least 1500mm.

Where any vertical fanned draught chimney configuration outlet is within 2000mm measured horizontally of an opening window, then it shall be at least 300mm above the opening.

**Note.**

The equivalent flue length resistance of the elbow kits are:

90° elbow kit = 1m

45° elbow kit = 0.6m

## 2.14 ASSEMBLING THE ROOF FLUE KIT

Determine the correct height that the flue should terminate above the roof. If after calculating or measuring the overall flue height from the top of the boiler, it is necessary to cut both pipes of assembly A, then ensure they are cut equally leaving the inner flue tube longer than the outer air tube as supplied.

Ensure the cut pipe ends are free from any burrs.

1. Position the roof flashing plate (supplied separately) over the hole cut in the roof and insert flue terminal from the roof end.

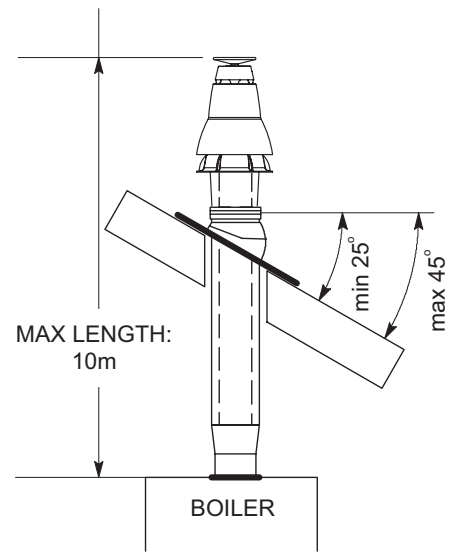
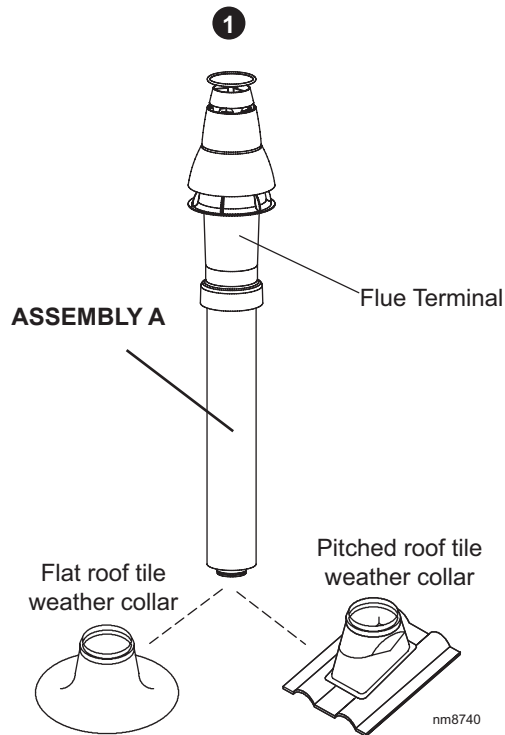

2. Fit the vertical connector (supplied separately) in accordance with the instructions provided with the vertical connector kit.
3. Secure the vertical connector by applying downward pressure on the connector.
4. Position the clamp on the top face of the flue manifold and push it horizontally backwards. Locate both clamp lugs into the flue manifold and secure to the flue manifold with the M5 retaining screw (as shown in Section 2.10).
5. Push extension duct (if required (supplied separately)) into vertical connector.

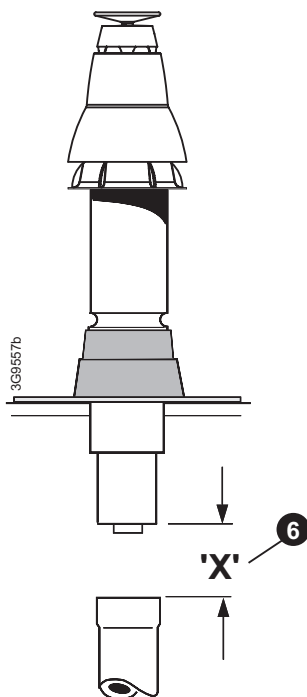
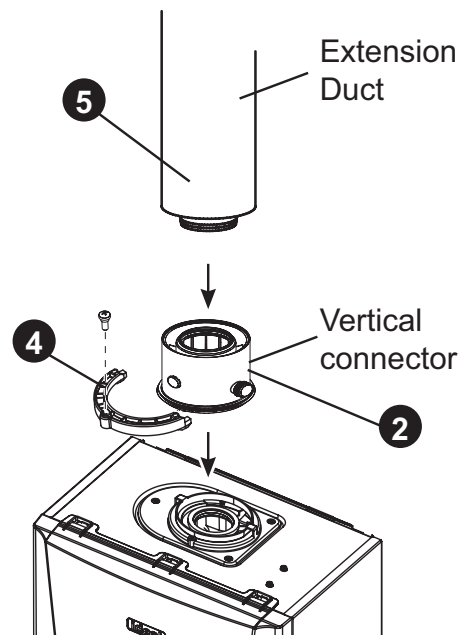

6. If the last extension duct requires cutting, measure 'X', the distance (outer ducts), between the duct and the terminal and add 100 mm to this dimension. This gives the length of the last extension duct.

**Note.** Check the position of the inner flue duct relative to the outer duct on the assembled extension duct(s) and ensure the terminal flue duct is cut longer than the air duct to ensure engagement in the final flue duct seal.

7. Finally ensure the roof flashing plate is correctly sealed to the roof.

2.15 CONNECTIONS & FILLING

NOTES.

Ensure all boss blanking plugs are removed before connecting hardware. Each valve must be fitted to the correct boss as shown in the picture.

Ensure each union is fitted with fibre seals provided.

Do not subject any of the isolating valves to heat as the seals may be damaged.

**Note.** The domestic hot water flow rate is automatically regulated to a maximum:  
 26 = 10.7 l/m (2.2 gpm)  
 32 = 13.1 l/m (2.8 gpm)  
 40 = 16.4 l/m (3.2 gpm)

WATER CONNECTIONS CH

1. Connect the CH flow service valve (black handle) and copper tail provided in the hardware pack to the threaded boss connection provided at the lower rear of the boiler.
2. Connect the CH rtn. valve (black handle) and copper tail.

WATER CONNECTIONS DHW

1. Fit the DHW inlet service valve (blue handle) and copper tail to the threaded boss connection ensuring the seal provided is correctly located.
2. Fit the DHW outlet pipe tail to DHW outlet connection, ensuring the seal provided is correctly located.
3. Fit the filling loop provided between the DHW inlet valve and the CH return valve.

GAS CONNECTION

**IMPORTANT.** The gas service cock is sealed with a non-metallic blue fibre washer, which must not be overheated when making capillary connections. Refer to Section 1.17 for details of the position of the gas connection.

For additional gas supply info refer to Section 1.9 - Gas Supply

SAFETY VALVE DRAIN

The safety valve connection, located at the bottom right-hand side of the boiler, comprises a 15mm diameter stub pipe.

The Installer to provide a compression joint on the end of the stub pipe. This assists with pipe removal when servicing.

The discharge pipe should be positioned so that the discharge of water or steam cannot create a hazard to the occupants of the premises or damage the electrical components and wiring.

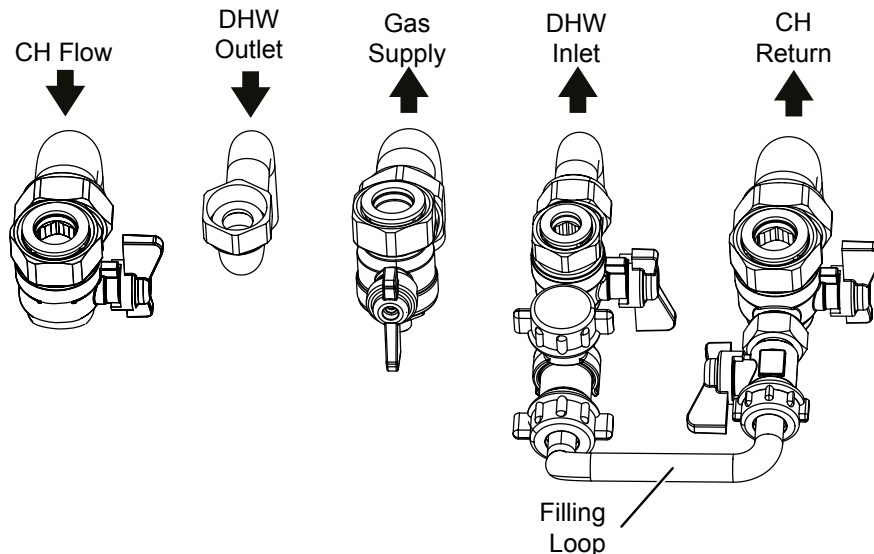
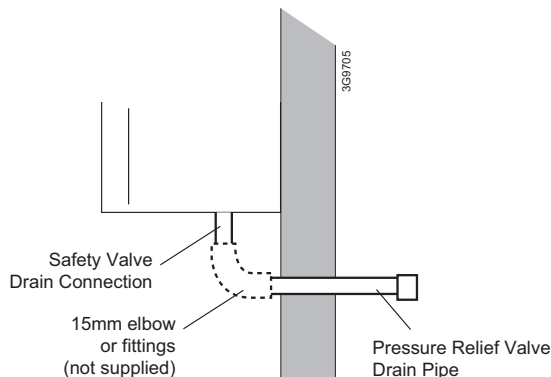

Cont'd.....

## SECTION 2 - INSTALLATION

### CONNECTIONS & FILLING - CONT.....

#### FILLING

##### IMPORTANT - when filling:

When filling there may be a slight water leak from the air vent therefore electrical connections should be protected.

##### Filling

1. Ensure filling loop is connected and all washers in place.
2. Ensure dust cap on auto air vent is slackened off.
3. Check the following isolation handles on water connections are in the horizontal filling position (blue handle on DHW inlet **A** and black handle on CH return **C**).

**Note.** The CH flow isolation valve handle **MUST** be in the vertical position to enable filling.

4. Slowly turn the filling loop handle (blue **B**) to the horizontal open position until the pressure gauge reads between 1 to 1.5 bar.
5. Once the pressure gauge dial reads between 1 to 1.5 bar turn the filling loop handle (blue **B**) back to the closed (vertical) position.
6. Turn the CH Return handle (black **C**) and the DHW Inlet handle (blue **A**) to the open (vertical) position.
7. Disconnect the filling loop from the DHW Inlet valve and fit the grey cap to the open end.
8. Fit the Plug to the free end of the filling loop.

Note. Open all DHW taps to ensure water is flowing freely. Once satisfied close all taps.

##### Top Up

1. Ensure filling loop is connected and all washers in place.
2. Ensure dust cap on auto air vent is slackened off.
3. Turn the DHW Inlet handle (blue **A**) to the horizontal position.
4. Slowly turn the filling loop handle (blue **B**) to the horizontal open position until the pressure gauge reads between 1 to 1.5 bar.
5. Once the pressure gauge dial reads between 1-1.5 bar turn the handle (blue **B**) on the filling loop back to the closed (vertical) position.
6. Turn the DHW Inlet handle (blue **A**) to the open (vertical) position.
7. Disconnect the filling loop from the DHW Inlet valve and fit the grey cap to the open end.
8. Fit the Plug to the free end of the filling loop.

Note. Open all DHW taps to ensure water is flowing freely. Once satisfied close all taps.

Filling Positions shown

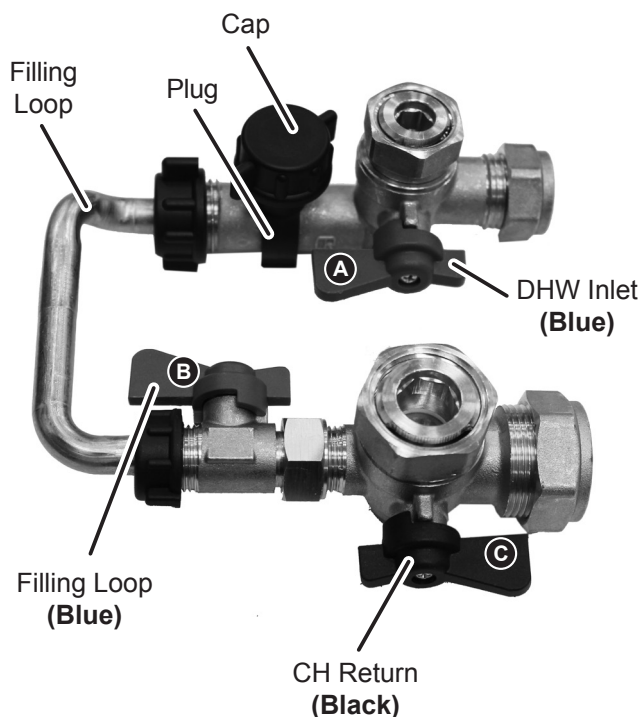

Top Up Positions shown

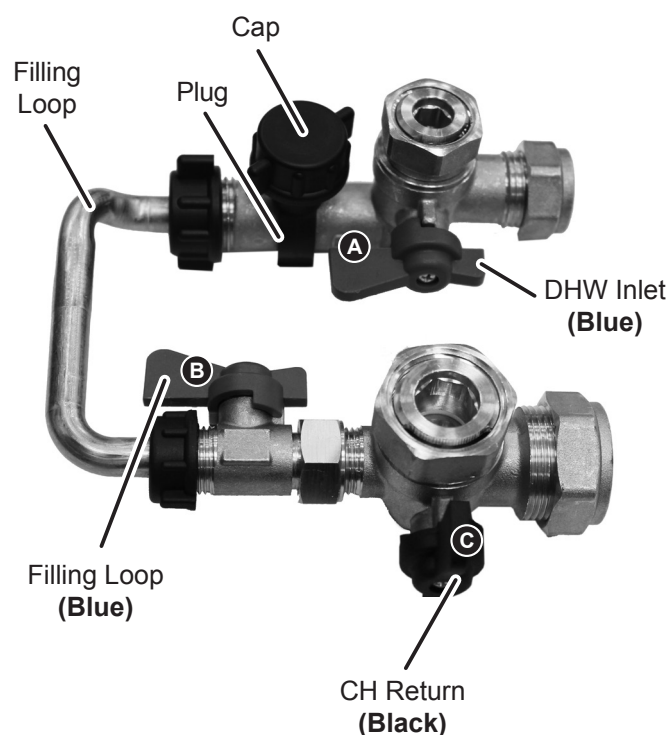



## SECTION 2 - INSTALLATION

### 2.16 ELECTRICAL CONNECTIONS

**WARNING.** This appliance MUST be earthed.

A mains supply of 230Vac ~ 50 Hz is required.

The fuse rating should be 3A. All external controls and wiring must be suitable for mains voltage.

Wiring external to the boiler MUST be in accordance with the current IET (BS.7671) Wiring Regulations and any local regulations.

Wiring should be 3 core PVC insulated cable, not less than 0.75mm<sup>2</sup> (24 x 0.2mm), and to BS 6500 Table 16. For IE reference should be made to the current ETCI rules for electrical installations.

Connection must be made in a way that allows complete isolation of the electrical supply such as a double pole switch having a 3mm contact separation in both poles. The means of isolation must be accessible to the user after installation.

### 2.17 INSTALLER WIRING - MAINS

The Vogue Combi GEN2 boiler comes pre-fitted with 1.8m of mains cable. This must be connected to a permanent live supply and NOT switched by thermostats/programmers. If the supply cord is damaged, it must be replaced by the manufacturer, service agent or similarly qualified persons in order to avoid hazard.

#### Accessing the installer wiring

1. Isolate the mains supply from the boiler.
2. Remove the front panel. Refer to section 3.2.
3. Swing down the control box into the service position, remove the retaining screw, and remove the installer wiring cover.

All of the connections can now be readily accessed, the plugs can be removed to aid wiring.

Note the cable strain relief system and grommets. Once any wiring is completed, to secure the boiler, reverse the order above.

**Note 1** The link wire on the 230V installer room stat/timer connection gives a demand in conjunction with the OpenTherm link wire (located on the right hand side of the control box).

### INSTALLER CONNECTIONS

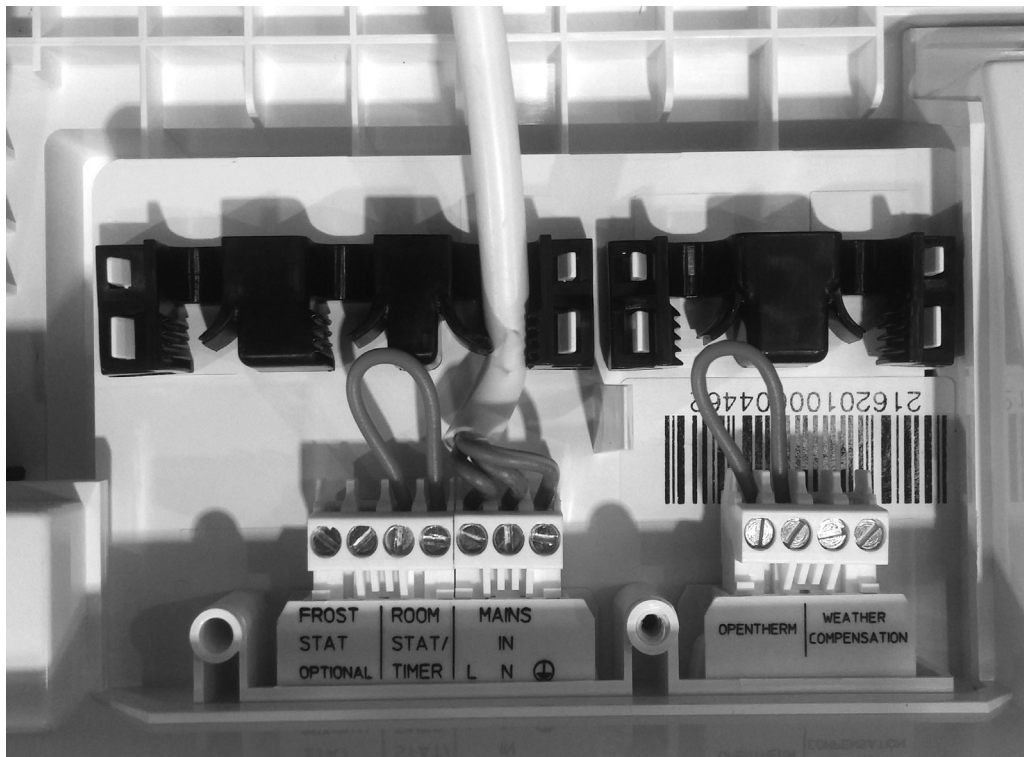

## SECTION 2 - INSTALLATION

### 2.18 OPTIONAL SYSTEM CONTROLS KITS

Ideal offers the following kits:-

(see individual kits for installation instructions)

**Mechanical Timer (24 hr):** 24 hour mechanical CH timer fits into the control box of the boiler. This can be fitted in conjunction with a Room Thermostat.

**RF Electronic 7 Day Programmable Room Thermostat:** Transceivers fit into boiler. Room thermostat can be located as desired.

**Weather Compensation Kit:** allows outside temperature sensing.

### 2.19 INTERNAL WIRING - EXTERNAL CONTROLS

The Vogue Combi GEN2 boiler comes pre-fitted with a link wire between the Room Thermostat/Timer connections on the terminal strip. This creates a permanent call for heat and must be removed when adding a Room Thermostat/Timer.

To add wired external Room Thermostats, Timers or Programmers proceed as follows:-

1. Isolate the mains supply to the boiler.
2. Remove the front panel (refer to Section 3.2).
3. Swing the control box down into the servicing position (refer to Section 3.3).
4. Route incoming cables through the grommets in the bottom panel (note: grommets are 'blind' and will require puncturing) and secure using clamps and screws provided in the hardware pack.
5. Remove the installer wiring cover.
6. Connect wires to the plugs which may be removed to aid wiring.
7. Re-assemble in reverse order.



## SECTION 2 - INSTALLATION

### 2.20 EXTERNAL WIRING

#### External Controls – 230V 50Hz

Wiring a 230V 50Hz Room Thermostat, Diagram A (with optional timer, Diagram B)

1. Remove the link wire from the room stat/timer plug.
2. Connect the external cable from the room stat/timer across these two connections, if a general live connection is used for the room stat or timer then connect this to the fused spur, on the load side (see Diagram C)
3. If the room thermostat has compensation and requires a neutral connection, make this connection to the fused spur, on the load side.

#### Optional External Controls – Extra Low Voltage

Wiring OpenTherm Room Control or other OpenTherm Master Device, Diagram D.

1. Locate the OpenTherm connection on the right hand side of the boiler installer connections area, remove the violet link wire and connect the 2 core cable from the OpenTherm device.

#### Frost Protection

If parts of the pipework run outside the house or if the boiler will be left off for more than a day or so then a frost thermostat should be wired into the system.

This is usually done at the programmer, in which case the programmer selector switches are set to OFF and all the other controls MUST be left in the running position.

The frost thermostat should be sited in a cold place but where it can sense heat from the system.

Wiring a system frost thermostat, see diagrams A, B and C. Wire the frost thermostat across the two connections as shown.

**Note.** If the boiler is installed in a garage it may be necessary to fit a pipe thermostat, preferably on the return pipework.

**DIAGRAM A:**

Programmable Room Stat or Room Stat with Internal Timer

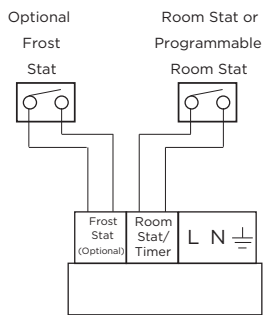

**DIAGRAM B:**

Room Stat with External Timer

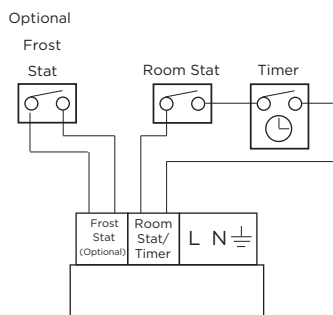

**DIAGRAM C:**

Use of General Live for Room Stat

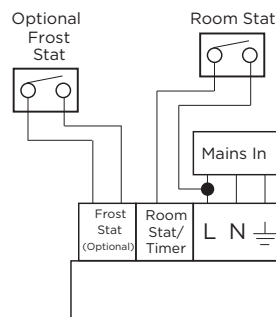

**DIAGRAM D:**

OpenTherm Device

**DO NOT CONNECT 230V TO THESE TERMINALS OR THE BOILER ELECTRONICS WILL BE DAMAGED**

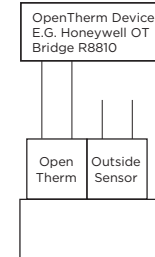

### 2.21 REPLACING PRE-FITTED MAINS CABLE

If it is necessary to use an alternative mains cable to the one pre-fitted then use the following guide.

Replacement wiring should comply with notes in Section 2.18 and be carried out by a qualified person to avoid a hazard.

1. Isolate the mains supply to the boiler.
2. Remove the front panel. Refer to Section 3.2.
3. Swing the control box down into the service position, remove retaining screw, and remove the installer wiring cover. Refer to Section 3.3.
4. Unplug the mains connector and release the cable from strain relief.
5. Unscrew the L N & E connections & remove wires from connector.
6. Remove the mains cable by pulling back through the grommet .
7. Route the replacement cable through the grommet and re-fit in reverse order.
8. Refit the installer wiring cover ensuring that it is located correctly and that the cable is retained into the strain relief as shown.
9. Swing the control box back up into the operating position and re-fit the front panel ensuring a good seal is made.

**NOTE.** When making the mains electrical connections to the boiler it is important that the wires are prepared in such a way that the earth conductor is longer than the current carrying conductors, such that if the cord anchorage should slip, the current carrying conductors become taut before the earthing conductor.

Strain Relief

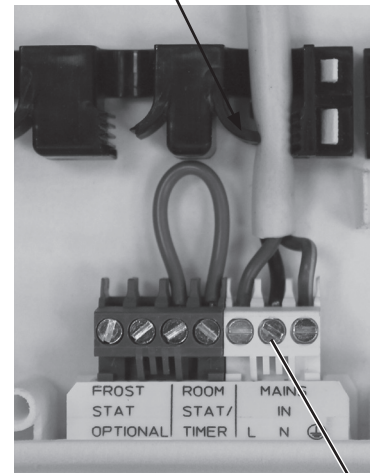

4

# SECTION 2 - INSTALLATION

## 2.22 WIRING DIAGRAM

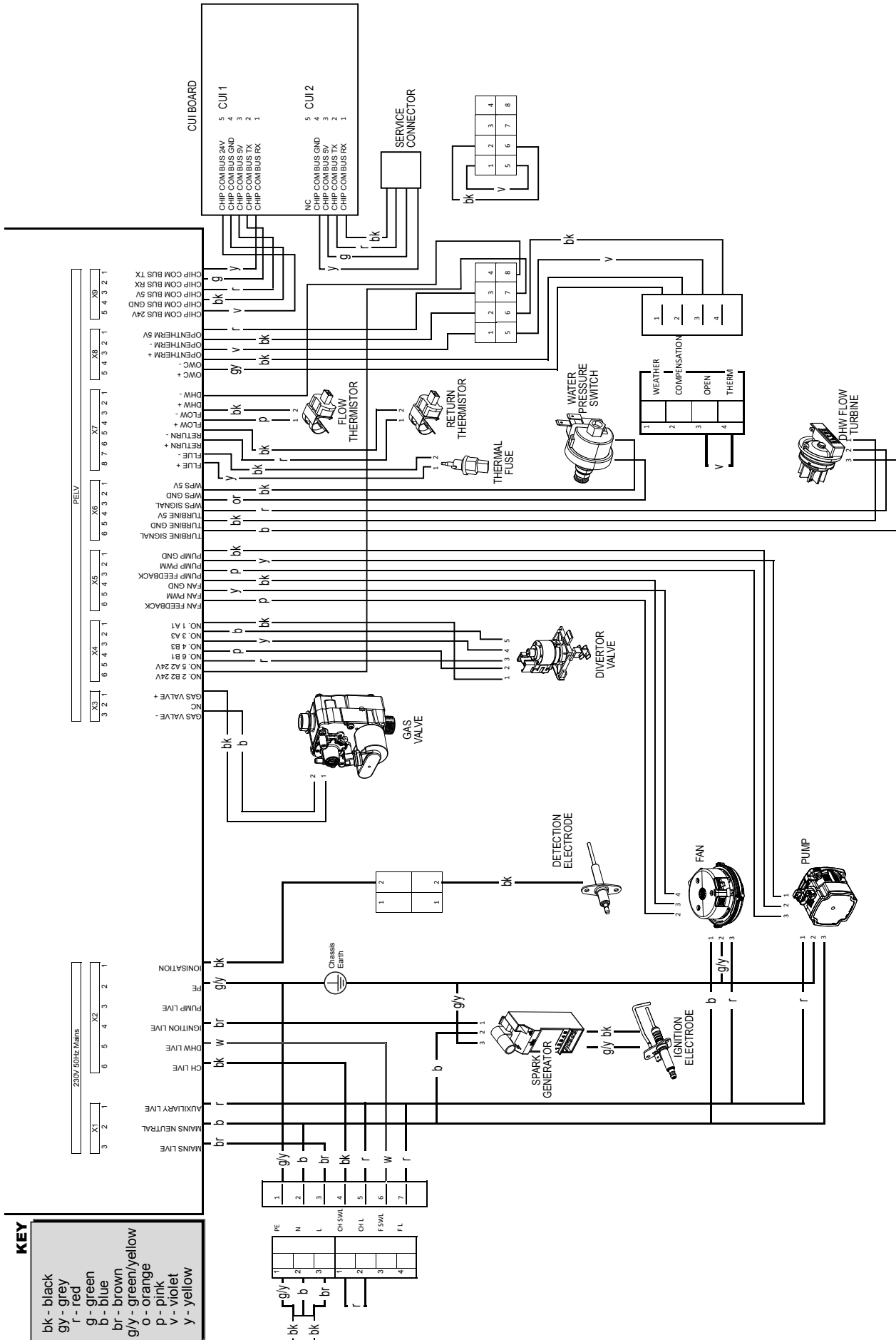

### 2.23 COMMISSIONING AND TESTING

#### A. Electrical Installation

1. Checks to ensure electrical safety should be carried out by a competent person.
2. ALWAYS carry out the preliminary electrical system checks, i.e. earth continuity, polarity, resistance to earth and short circuit, using a suitable test meter.
3. After wiring the boiler, all grommets in the bottom panel MUST be in place to ensure that boiler case sealing is maintained.

#### B. Gas Installation

1. The whole of the gas installation, including the meter, should be inspected and tested for tightness and purged in accordance with the recommendations of BS. 6891. In IE refer to IS.813.
2. Purge air from the gas installation by the approved methods only.

**WARNING.** Whilst effecting the required gas tightness test and purging air from the gas installation, open all windows and doors, extinguish naked lights and **DO NOT SMOKE.**

#### GENERAL

**Please Note:** The combustion for this appliance has been checked, adjusted and preset at the factory for operation on the gas type defined on the appliance data plate. **DO NOT** adjust the air/gas ratio valve.

Having checked:

- That the boiler has been installed in accordance with these instructions.
- The integrity of the flue system and the flue seals, as described in the Flue Installation section.

Proceed to put the boiler into operation as follows:

#### CHECK THE OPERATIONAL (WORKING) GAS INLET PRESSURE

To set up the boiler to operate at maximum DHW rate, open one HW tap fully or refer to page 46, "Service Mode Maximum DHW Rate". This mode will operate the boiler at maximum heat output but through the central heating circuit. To ensure the boiler is operating at maximum this must be carried out when the system is cool.

With the boiler operating in the maximum rate condition check that the operational (working) gas pressure at the inlet gas pressure test point complies with the requirements - refer to Section 1.9 - Gas Supply.

Ensure that this inlet pressure can be obtained with all other gas appliances in the property working.

#### SERVICE

When the boiler has been installed for more than 1 year a message similar to the following screen will appear:

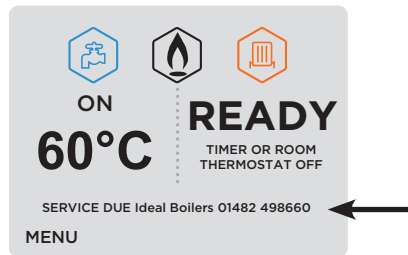

Gas Supply

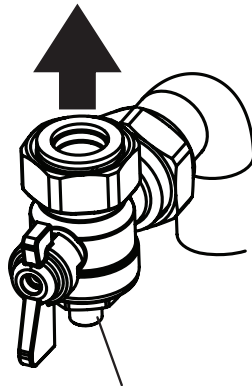

Gas Pressure  
Test Point

**As part of the commissioning process, the combustion of this appliance must be checked and the Benchmark Checklist completed. A flow chart to assist is provided on page 80.**

**ATTENTION !**  
IT IS A CONDITION OF THE MANUFACTURERS WARRANTY THAT THE BENCHMARK COMMISSIONING CHECKLIST IS FULLY COMPLETED AND LEFT WITH THE APPLIANCE

## SECTION 2 - INSTALLATION

### 2.24 INITIAL LIGHTING

#### Legend

- A. Boiler Status
- B. Burner on Indication
- C. Hot keys
- D. CH Temperature Control
- E. DHW Temperature Control and Boiler Off Switch
- F. Pressure Gauge
- G. CH Flow
- H. Gas Inlet Pressure Test Point
- I. Gas Service Cock
- J. DHW Inlet Valve
- K. CH Return Isolating Valve
- L. DHW Outlet
- M. Filling Loop

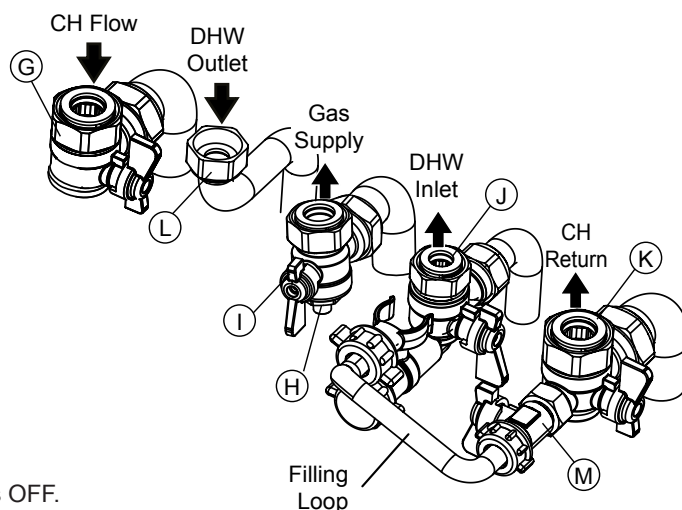
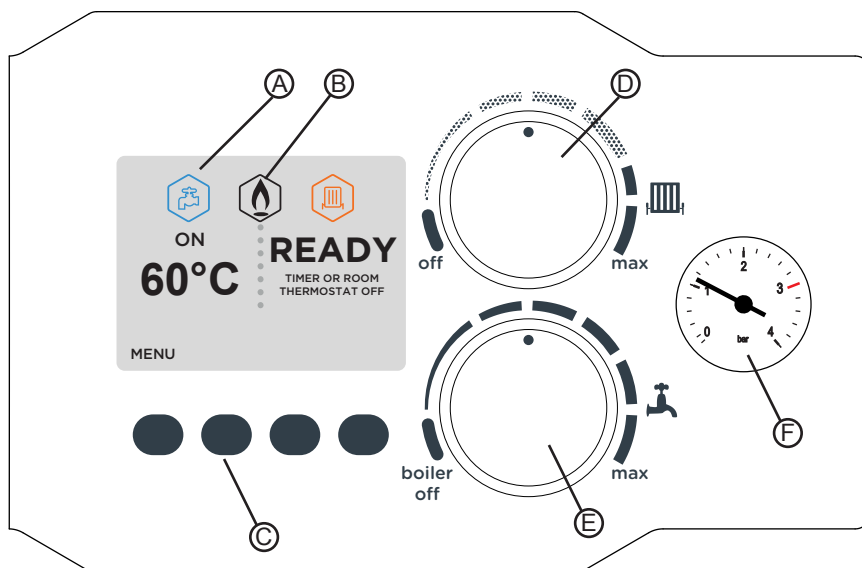

#### PREPARATION FOR IGNITION

1. Check that the electrical supply is OFF.
2. Check that the system has been filled and that the boiler is not air locked.
3. Ensure that the automatic air vent cap is open. Refer to Section 3.27.
4. To assist with venting the air from the system, refer to Page 44 Vent System. This function operates the boiler to ensure efficient venting of the boiler and system.
5. Refit the boiler front panel. Refer to Section 3.2.
6. Check that the drain cock is closed and that the CH (G & K) and DHW (J) isolating valves are OPEN.
7. Check that the DHW Temperature Control Knob (E) is turned fully anti-clockwise into the off position.
8. Check that the gas service cock (I) is OPEN.
9. Slacken the screw in the inlet pressure test point (H) and connect a gas pressure gauge via a flexible tube.

#### INITIAL IGNITION

1. Switch the electricity supply ON and check all internal and external controls are calling for heat.
2. Set the CH Temperature Control (D) to max and set the DHW Temperature Control (E) to max. The boiler will now go through its ignition sequence until the burner is established.

3. If the boiler has not lit, after 5 ignition attempts, the following screen will be displayed.



4. Restart the boiler and the ignition sequence will be repeated. If restart occurs 5 times within 15 minutes then the following screen will be displayed.

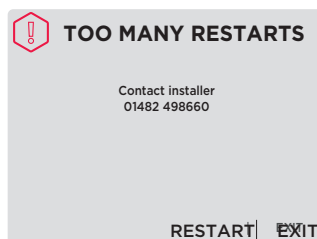

If power is removed this will be restarted.

## 2.25 CHECK CH & DHW OPERATION

### CENTRAL HEATING

When the burner is established the following screen will be displayed.



The temperature shown will be the actual Flow Temperature.

Set the timer or Programmable Room Stat to be off. The burner will go off and the fan and pump continue to run for 2 minutes. The following screen will be displayed.

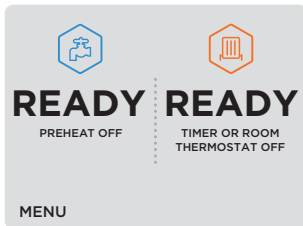

Check the correct operation of all the system controls by operating each control separately and check that the main burner responds.

### DOMESTIC HOT WATER

Fully open a DHW tap. The boiler will continue to run and the following screen will be displayed.

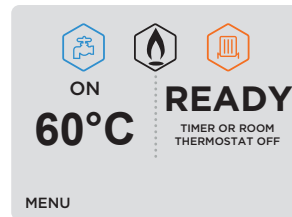

The temperature shown will be the actual DHW temperature.

Close all taps except the largest draw off (bath) and check that the boiler is firing in DHW. This is factory set to give a DHW temperature rise of approximately 35°C at the flow rate stated in Section 1.2 - Operation.

At full DHW output check the gas rate at the gas meter with no other appliances in use. Refer to Section 1.9 for gas rates. Ensure that, with the boiler operating, the dynamic gas pressure is able to obtain maximum output. Refer to Table 1.

**Note.** to achieve maximum output in DHW operation all taps may need to be opened.

Fully open all DHW taps in turn and ensure that water flows freely.

Reduce the DHW draw off rate to about 3 l/min and check that the boiler modulates to deliver DHW at approximately 65°C (with the DHW temperature control knob set to maximum).

Close the DHW tap and check that the main burner extinguishes. The pump will overrun for 60 seconds while the fan overruns for 10 seconds. The following screen will be displayed.



### IMPORTANT

The gas input to the burner is regulated by the gas valve according to the air flow produced by the fan. It is NOT user-adjustable. Any interference to sealed settings on the gas valve will adversely affect operation and render warranty void. For additional information refer to Section 1.9 - Gas Supply.

**Note:** on systems in excess of 2 bar inlet pressure, a water pressure governor may be required to prevent water noise.

2.26 DISPLAY FUNCTIONS IN NORMAL OPERATION

**Boiler Switched Off:**  
DHW Knob in Off Position

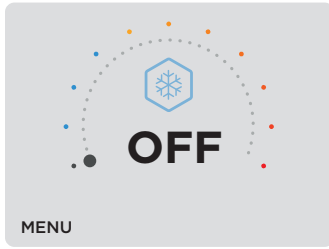

**DHW Demand On, CH Demand On**

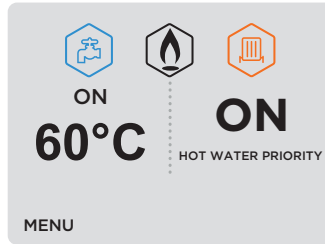

**DHW Demand Off:**  
(CH Knob in Off Position)

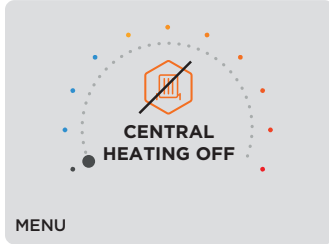

**Pre-heat Demand On**

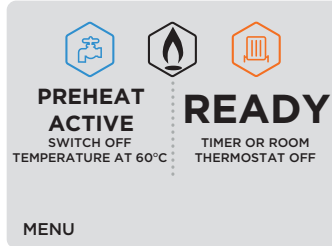

**Boiler Frost Protection:** occurs if Flow Temperature less than 5°C

**DHW Demand On:**  
(CH Knob in Off Position)

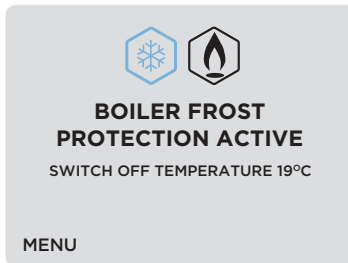
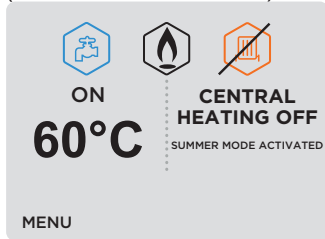

**DHW Demand Off, CH Demand Off**  
Preheat disabled

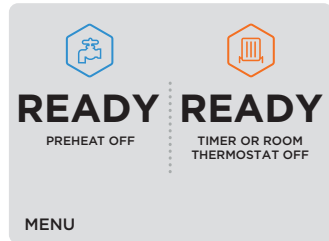

**Service Due:**  
shown after 12 months operation, see Section 2.24 to restart

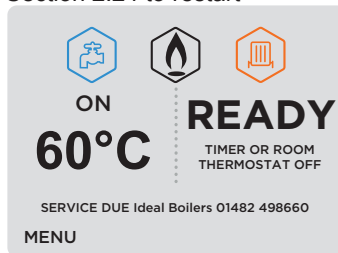

**DHW Demand Off, CH Demand Off**  
Preheat enabled



**DHW Demand off**  
CH Demand on

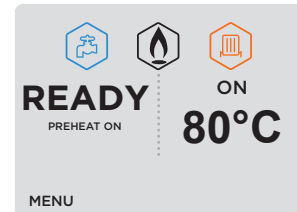



## 2.27 CHANGING SETTINGS

### To change the DHW Temperature Set Point

Rotate the DHW Temperature Control Knob, the screen below will be shown

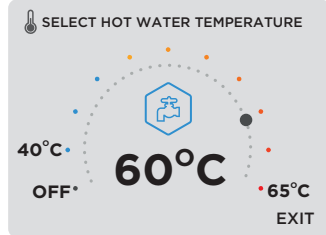

### To change the Flow Temperature Set Point:

Rotate the CH Temperature Control Knob, the screen below will be shown

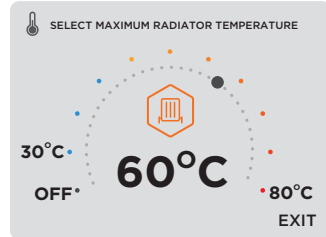

### To switch CH function ON:

Rotate the CH Temperature Control Knob clockwise, the screen below will be shown

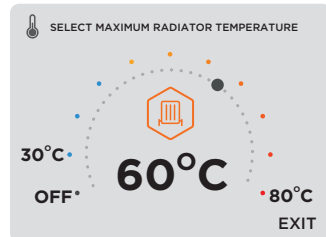

### To switch the CH function OFF:

Rotate the CH Temperature Control Knob fully anti-clockwise, the screen below will be shown

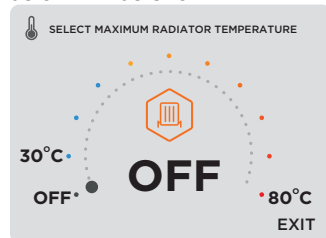

### To disable DHW and CH:

Rotate the DHW Temperature Knob fully anti-clockwise, the screen below will be shown  
(frost protection still active)

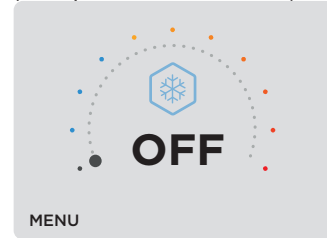

### To switch the boiler On:

Rotate the DHW Temperature Knob clockwise, the screen below will be shown

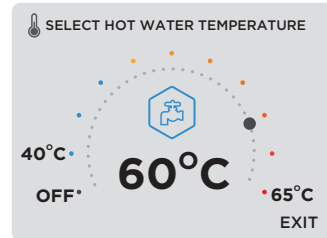

**To change the Room Temperature Set Point** (only if Outside Sensor connected): rotate the CH Temperature Knob, the screen below will be shown

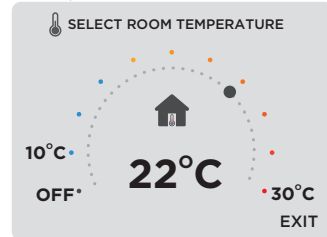

2.28 MENU OPERATION

EFFICIENCY LEVEL

To view the efficiency level of the boiler press MENU and the following screen will be displayed.

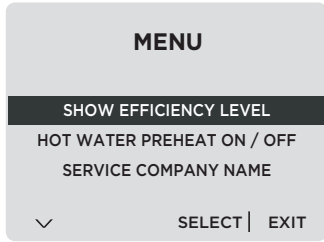

Press SELECT and the following screen will be displayed.

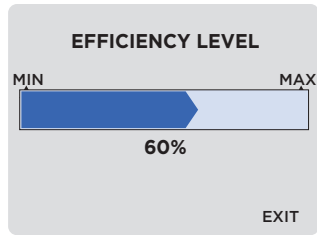

PRE-HEAT

If pre-heat is switched on then the boiler will periodically fire the burner thereby reducing the time taken to provide hot water. If pre-heat is switched off the response time will be reduced although gas consumption will also be reduced.

Press ENTER and the following screen will be displayed

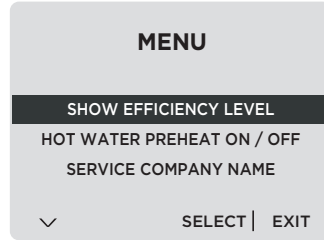

Press  $\downarrow$  until the following screen is displayed.

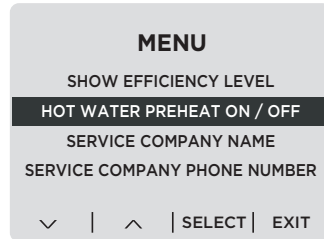

Press SELECT and a screen similar to the following will be displayed.

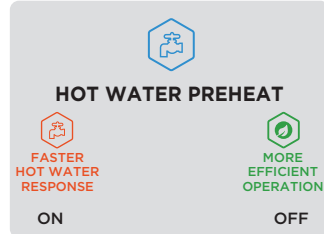

To switch Pre-heat off press OFF  
To switch Pre-heat on press ON.

INSTALLERS DETAILS

The service required message which is displayed after 12 months can be customised to show the installer's telephone number and name. To record your telephone number and name press MENU and the following screen will be displayed.

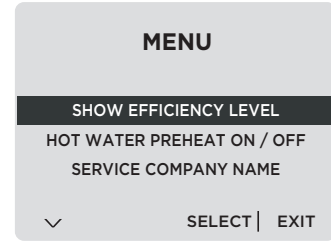

Press  $\downarrow$  until the following screen is displayed.

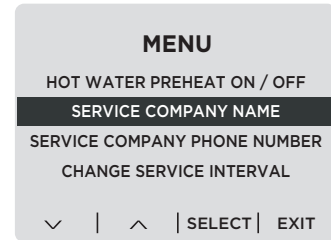

Press SELECT and a screen similar to the following will be displayed.



Press  $\downarrow$  and  $\uparrow$  to change the letters. Press NEXT to move to next letter. Press SET to accept then press  $\downarrow$  on the next screen to show the following.

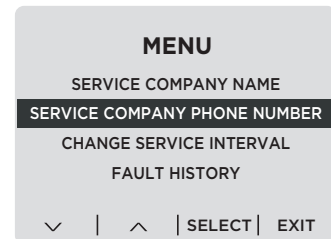

Press SELECT and a screen similar to the following will be displayed.



Press  $\downarrow$  and  $\uparrow$  to change the number. Press NEXT to move to next digit. Press SET to accept then press EXIT to end.

## SECTION 2 - INSTALLATION

### MENU OPERATION - CONT'D

#### RESET SERVICE INTERVAL

If the boiler has not been serviced within the last 12 months then a message will be displayed indicating this. To reset this timing proceed as follows. Press MENU and the following screen will be displayed.

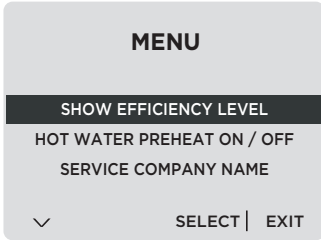

Press  $\downarrow$  until the following screen is displayed.

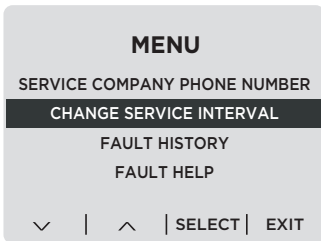

Press SELECT and the following screen will be displayed.

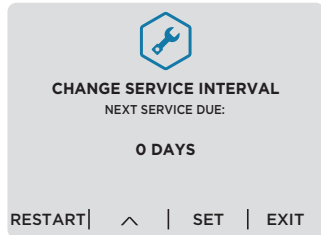

Press  $\downarrow$  or  $\wedge$  for desired days, then press SET and then press EXIT.

#### FAULT HISTORY

To view the Fault History of the boiler press MENU and the following screen will be displayed.

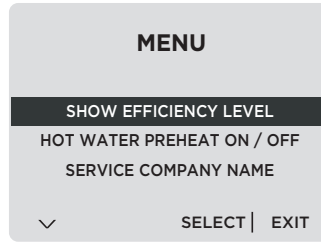

Press  $\downarrow$  until the following screen is displayed.

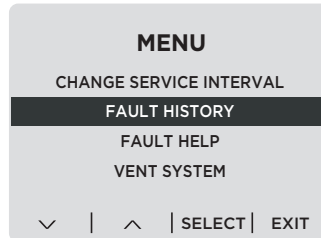

Press SELECT and a screen similar to the following will be displayed.

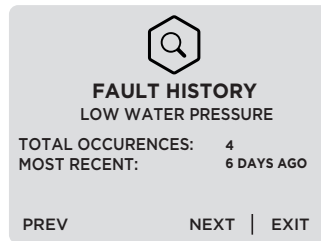

Press 'NEXT' to view the full list. Press EXIT twice to return to normal operation.

#### FAULT HELP

This feature provides a list of potential corrective actions at an installer level for all faults detectable by the boiler electronics. Press MENU and the following screen will be displayed.

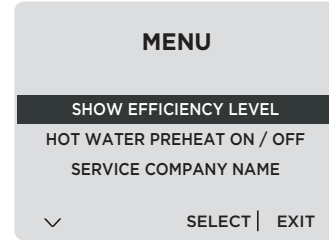

Press  $\downarrow$  until the following screen is displayed.

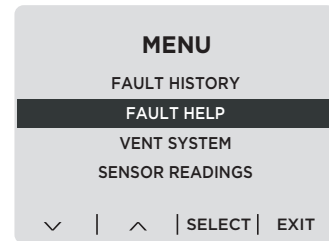

Press SELECT and the following screen will be displayed.

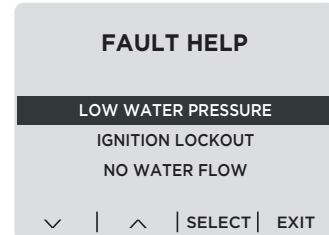

Press  $\downarrow$  and  $\wedge$  until the desired fault is shown then press SELECT and a screen similar to the following will be shown.

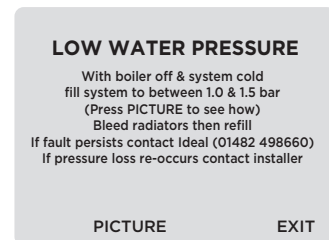

Press EXIT twice when finished.

## MENU OPERATION - CONT'D

### VENT SYSTEM

The Vent System feature aids removal of air from the heat exchanger. The pump will be switched on for 50s and then off for 10s while the diverter valve is moved between DHW and CH every 30s. The feature lasts for 5 minutes.

Press MENU and the following screen will be displayed.

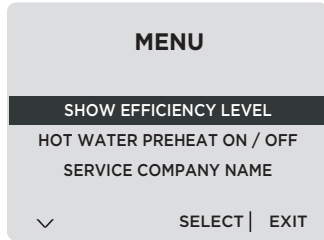

Press  $\nabla$  and the following screen is displayed.

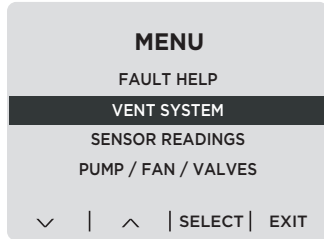

Press SELECT and the following screen will be displayed.

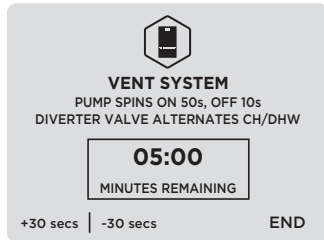

The feature will end automatically after 5 minutes, to end manually press END.

### SENSOR READINGS

To view the current Water Pressure, Switched Live Status, DHW Flow Rate, DHW Temperature, Flow Temperature, Return Temperature, Flame Status, Outside Temperature, DHW Switched Live Status and OpenTherm Status, press MENU and the following screen will be displayed.

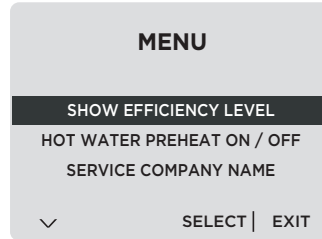

Press  $\nabla$  until the following screen is displayed.

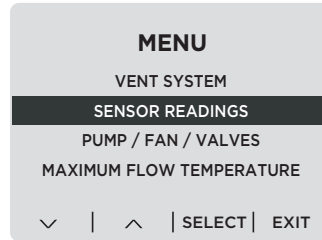

Press SELECT and a screen similar to following will be displayed.

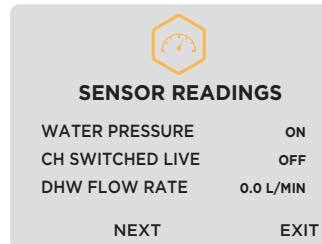

Press 'NEXT' to view the full list. Press EXIT twice to return to normal operation.

### PUMP / FAN / VALVES

To view the current status of the Pump, Diverter Valve, Fan, Spark Generator and Gas Valve press MENU and the following screen will be displayed.

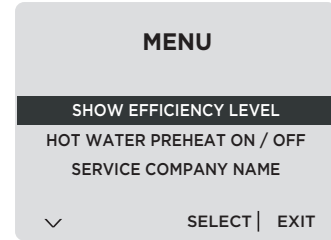

Press  $\nabla$  until the following screen is displayed.

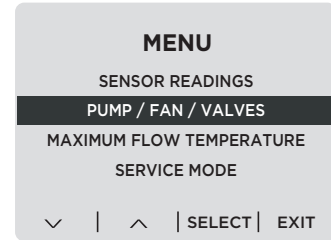

Press SELECT and a screen similar to the following will be displayed.

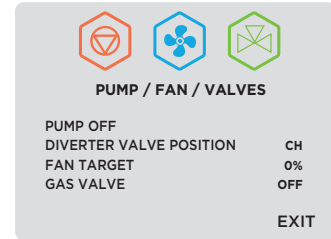

Press EXIT twice to return to normal operation.

## SECTION 2 - INSTALLATION

### MENU OPERATION - CONT'D

#### MAXIMUM FLOW TEMPERATURE

It is possible to limit the maximum flow temperature that can be set from the CH Flow Temperature knob using this feature. Note that this could prevent adequate room temperature being achieved in winter.

Press MENU and the following screen will be displayed.

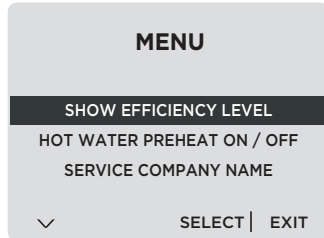

Press  $\nabla$  until the following screen is displayed.

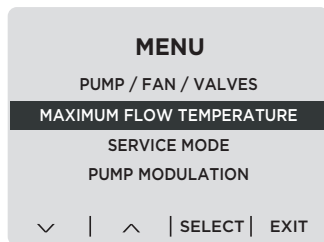

Press SELECT and a screen similar to following will be displayed.

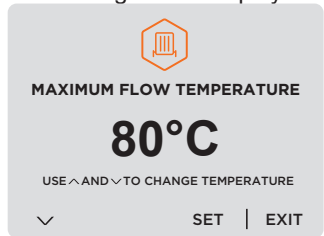

Press  $\nabla$  and  $\wedge$  until the desired temperature is displayed and then SET followed by EXIT to return to normal operation.

#### SERVICE MODE MINIMUM RATE

This feature will run the burner at minimum rate. Note that a CH demand has to already be present for this feature to be active. To activate the feature press MENU and the following screen will be displayed.

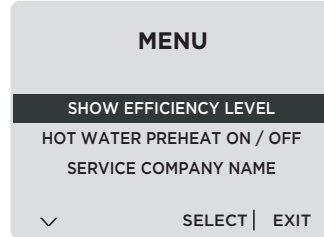

Press  $\nabla$  until the following screen is displayed.

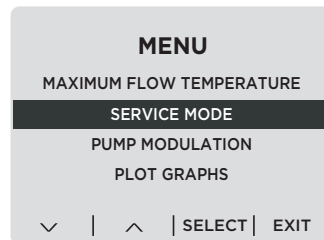

Press SELECT and the following screen will be displayed.

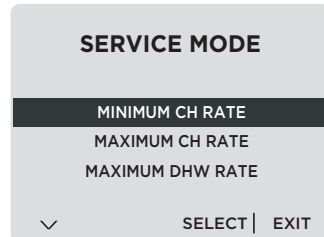

Press SELECT and the following screen will be displayed.

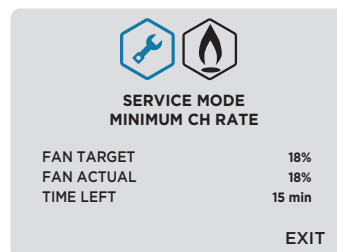

Operation will end automatically after 10 mins or press EXIT to end manually.

#### SERVICE MODE MAXIMUM CH RATE

This feature will run the burner at maximum CH rate. Note that a CH demand has to already be present for this feature to be active. Gas rate will reduce as flow temperature approaches 80°C. To activate the feature, press MENU and the following screen will be displayed.

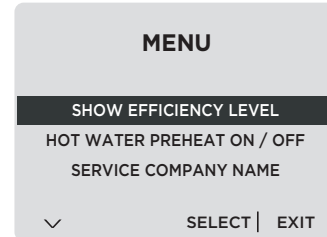

Press  $\nabla$  until the following screen is displayed.

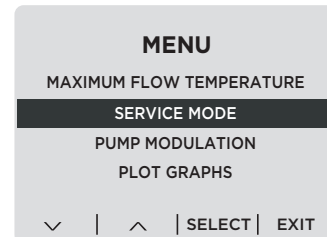

Press SELECT and the following screen will be displayed.

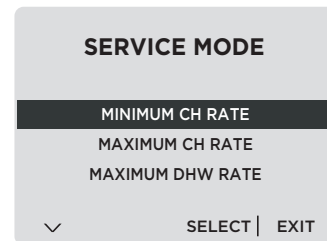

Press  $\nabla$  and the following screen will be displayed.

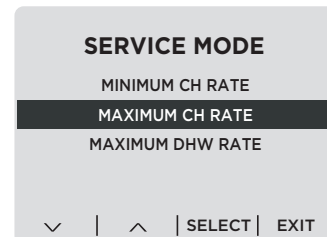

Press SELECT and the following screen will be displayed.

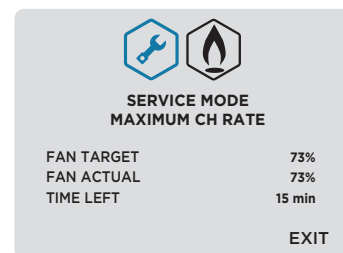

Operation will end automatically after 10 mins or press EXIT to end manually.

## SECTION 2 - INSTALLATION

### MENU OPERATION - CONT'D

#### SERVICE MODE MAXIMUM DHW RATE

This feature will run the burner at maximum DHW rate with the diverter valve in the CH position. Note that a CH demand has to be present for this feature to be active. Gas rate will reduce as flow temperature approaches 80°C. To activate the feature, press MENU and the following screen will be displayed.

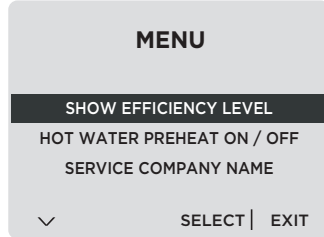

Press  $\downarrow$  until the following screen is displayed.

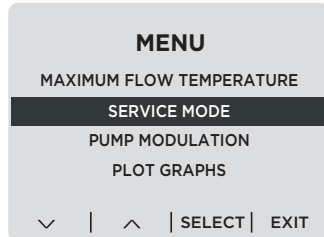

Press SELECT and the following screen will be displayed.

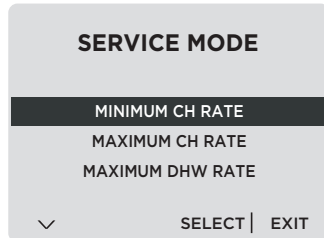

Press  $\downarrow$  and the following screen will be displayed.

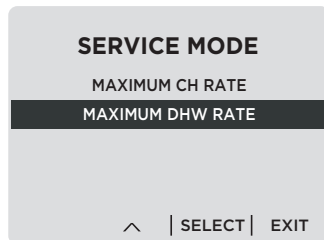

Press SELECT and the following screen will be displayed.

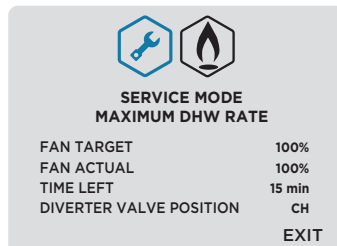

Operation will end automatically after 10 mins or press EXIT to end manually.

#### PUMP MODULATION

The boiler is factory set for pump modulation to occur. If you would like to disable modulation press MENU and the following screen will be displayed.

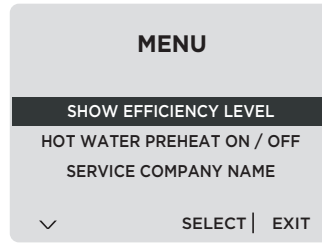

Press  $\downarrow$  until the following screen is displayed.

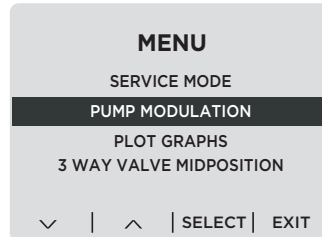

Press SELECT and the following screen will be displayed.

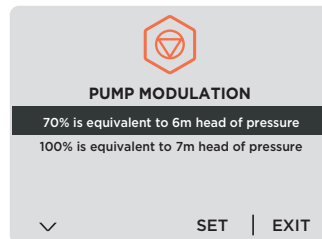

Press  $\downarrow$  or  $\uparrow$  to change the setting and press SET to enable.

#### OUTSIDE SENSOR SLOPE

This feature is only accessible if an Outside Sensor has been fitted to the boiler. Boiler performance can be adjusted relative to the insulation level of the building. To change the slope press MENU and the following screen will be displayed

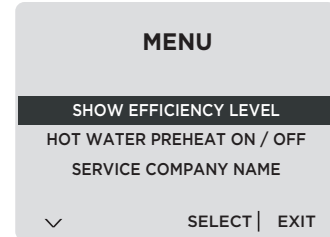

Press  $\downarrow$  until the following screen is displayed.

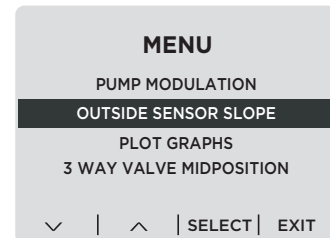

Press ENTER and the following screen will be displayed.

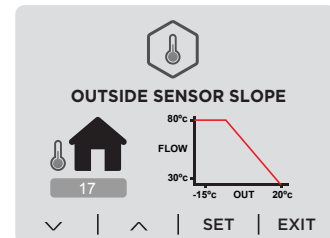

Press  $\downarrow$  and  $\uparrow$  until the desired setting is displayed.

Press SET followed by EXIT to return to normal operation.

**MENU OPERATION - CONT'D**

**PLOT GRAPHS**

To plot graphs of Water Pressure, Switch Live, DHW Flow Rate, DHW Temperature, Flow/Return Temperature, Flame Status, Outside Temperature or DHW Switched Live, press MENU and the following screen will be displayed.

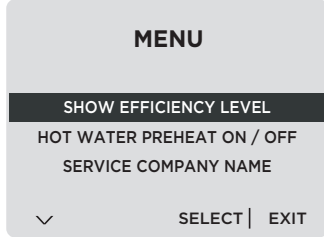

Press  $\downarrow$  until the following screen is displayed.

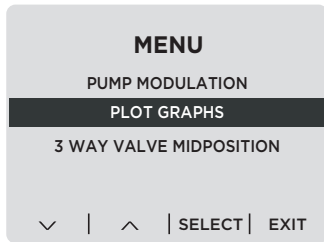

Press SELECT and the following screen will be displayed.

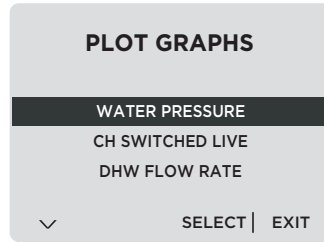

Press  $\downarrow$  and  $\uparrow$  to highlight the desired input and then press SELECT. A screen similar to the following will be displayed.

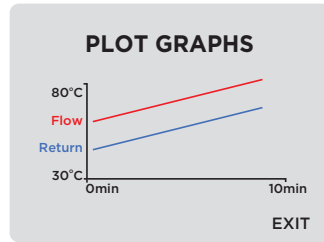

Press EXIT 3 times to end.

**3 WAY VALVE MID POSITION**

This feature will enable the 3 way valve to move to midposition to allow diverter valve removal. To access this menu the following will be displayed.

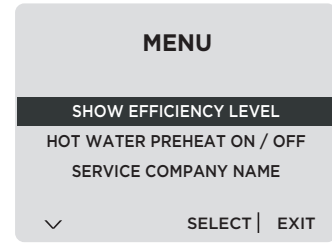

Press  $\downarrow$  until the following screen will be displayed.

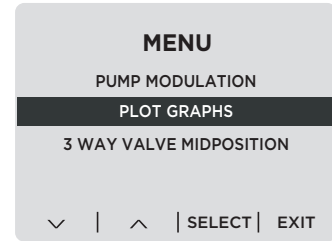

Press SELECT and the following screen will be displayed.

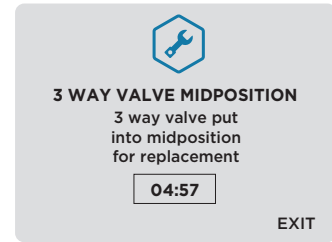

Press EXIT to end.

**2.29 GENERAL CHECKS**

**WATER CIRCULATION SYSTEM**

1. With the system COLD, check that the initial pressure is correct to the system design requirements.

For pre-pressurised systems, this should be 1.0 bar.

2. With the system HOT, examine all water connections for soundness. The system pressure will increase with temperature rise but should not exceed 2.5 bar.
3. With the system still hot, turn off the gas, water and electricity supplies to the boiler and drain down to complete the flushing process.

**Note:** A flushing solution should be used during the flushing procedure. Flushing solutions: Fernox F3 or DS40, Sentinel X300 (new systems) or X400 (existing systems).

4. Refill and vent the system (see Section 2.15), add inhibitor, clear all air locks and again check for water soundness.
5. Reset the system initial pressure to the design requirement.

6. Balance the system. Refer to Section 1.19.
7. Check the condensate drain for leaks and check that it is discharging correctly.
8. Finally, set the controls to the User's requirements.

**Notes.**

1. If the pump has not operated in the last 24 hours it will run briefly to prevent seizure
2. If the diverter valve has not operated in the last 24 hours it will be operated briefly to prevent seizure. These two operations will not occur at the same time.

**WATER TEMPERATURES**

Temperatures can be selected using the CH and DHW knobs.

Knob Setting	CH Flow Temp °C (°F)	DHW Outlet Temp °C (°F)
Max	80 (176)	65 (149)
Min	30 (86)	40 (104)

### 2.30 HANDING OVER

After completing the installation and commissioning of the system the installer should hand over to the householder by the following actions:

1. Make the householder aware that the user instructions are located in the pocket in the drop down door and explain his/her responsibilities under the relevant national regulations.
2. Explain and demonstrate the lighting and shutting down procedures.
3. The operation of the boiler and the use and adjustment of all system controls should be fully explained to the householder, to ensure the greatest possible fuel economy consistent with the household requirements of both heating and hot water consumption.

Advise the User of the precautions necessary to prevent damage to the system and to the building, in the event of the system remaining inoperative during frosty conditions.

4. Explain the function and the use of the boiler heating and domestic hot water controls.

Explain that due to system variations and seasonal temperature fluctuations DHW flow rates/temperature rise will vary, requiring adjustment at the draw off tap. It is therefore necessary to draw the users attention to the section in the Users Instructions titled "Control of Water Temperature" and the following statement:

**"Additionally, the temperature can be controlled by the user via the draw-off tap: the lower the rate the higher the temperature, and vice versa".**

5. Explain the function of the boiler fault mode.  
Emphasise that if a fault is indicated, the boiler should be turned off and a Gas Safe Registered Engineer consulted. In IE contact a Registered Gas Installer (RGII).
6. Explain and demonstrate the function of time and temperature controls, radiator valves etc., for the economic use of the system.
7. If a timer is fitted draw attention to the timer Users Instructions and hand them to the householder.

8. Loss of system water pressure.

Explain that the dial at the front RHS of the boiler indicates the central heating system pressure and that if the normal COLD pressure of the system is seen to decrease over a period of time then a water leak is indicated. Explain the re-pressurising procedure and if unable to re-pressurise or if the pressure continues to drop a registered local heating installer should be consulted.

9. Explain boiler restart procedure.

10. After installation and commissioning please complete the



Commissioning Checklist before handover to the customer. For IE, its is necessary to complete a "Declaration of Conformity" to indicate compliance to I.S. 813.

#### IMPORTANT

11. A comprehensive service should be carried out ANNUALLY.

Stress the importance of regular servicing by a Gas Safe Registered Engineer. In IE servicing work must be carried out by a Registered Gas Installer (RGII).

12. Inform the householder of the guarantee/registration found within the envelope pack and the requirement to register it to receive the full benefit of the warranty.



### 3.1 SERVICING SCHEDULE

For the very latest copy of literature for specification & maintenance practices, visit our website [idealheating.com](http://idealheating.com), where you will be able to download the relevant information.

**WARNING.** Always turn OFF the gas supply at the gas service cock, and switch OFF and disconnect the electricity supply to the appliance before servicing.

Combustion testing must be carried out by a competent person using a combustion analyser conforming to BS7927.

To ensure the continued safe and efficient operation of the appliance it is recommended that it is checked at regular intervals and serviced as necessary. The frequency of servicing will depend upon the installation condition and usage but should be carried out at least annually.

It is the law that any service work must be carried out by a Gas Safe Registered Engineer. In IE service work must be carried out by a Registered Gas Installer (RGII).

#### INSPECTION

1. Light the boiler and carry out a pre-service check, noting any operational faults.
2. Check the flue terminal (and terminal guard if fitted) is undamaged and clear of any obstruction.
3. Check all water and gas joints for signs of leakage. Remake any suspect joints ensuring a gas tightness check is carried out if applicable and the water system is correctly refilled, vented and re-pressurised.

#### CLEANING PROCEDURE

**Note.** In order to carry out either servicing or replacement of components the boiler front panel must be removed. Refer to Section 3.2.

1. Clean the main burner. Refer to Section 3.6.
2. Clean the heat exchanger & condensate trap/siphon. Refer to Section 3.7 & 3.8.
3. Check the main injector for blockage or damage. Refer to Section 3.5.
4. Check that the flue terminal is unobstructed and that the flue system is sealed correctly.

ALSO IF THE DHW FLOW RATE IS IN QUESTION :-

5. Check the DHW filter for blockage. Refer to Section 3.32.

The cleaning procedures are covered more fully in Sections 3.2 to 3.8 and MUST be carried out in sequence.

#### IMPORTANT.

6. After completing the servicing or exchange of components always ensure all gas valve connections are gas tight with a gas soundness check up to the gas control valve.
7. When work is complete the front panel MUST be correctly refitted, ensuring that a good seal is made.

**Do NOT OPERATE the boiler if the front panel is not fitted.**

8. If, for any reason, the condensate trap/siphon has been removed ensure the trap is refilled with water before reassembling.
9. Check the gas consumption.
10. Check combustion by connecting the flue gas analyser to the flue gas sampling point as shown in the diagram and measure CO & CO<sub>2</sub> at maximum rate. To set the boiler to Maximum and Minimum heat inputs see page 45. Repeat at minimum rate.

If the CO/CO<sub>2</sub> ratio is greater than 0.004 AND the integrity of the complete flue system and combustion circuit seals have been verified and the inlet gas pressure (and gas rate) have been verified, then contact Ideal.

11. Complete the service section in the Benchmark Commissioning Checklist.

#### GENERAL

**Please Note:** During routine servicing, and after any maintenance or change of part of the combustion circuit, the following must be checked:

- The integrity of the flue system and the flue seals
- The integrity of the boiler combustion circuit and the relevant seals
- The operational (working) gas inlet pressure at maximum rate
- The gas rate
- The combustion performance

#### COMPETENCE TO CARRY OUT THE CHECK OF COMBUSTION PERFORMANCE

**Please Note:** BS 6798. Specification for installation and maintenance of gas-fired boilers of rated input not exceeding 70kW net advises that:

- The person carrying out a combustion measurement should have been assessed as competent in the use of a flue gas analyser and the interpretation of the results.
- The flue gas analyser used should be one meeting the requirements of BS7927 or BS-EN50379-3 and be calibrated in accordance with the analyser manufacturers requirements, and
- Competence can be demonstrated by satisfactory completion of the CPA1 ACS assessment, which covers the use of electronic portable combustion gas analysers in accordance with BS7967, Parts 1 to 4.

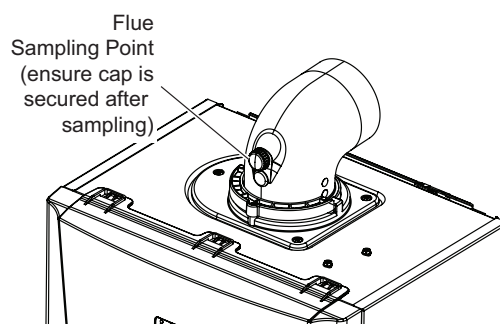

## SECTION 3 - SERVICING

### 3.2 BOILER FRONT PANEL REMOVAL / REPLACEMENT

#### REMOVAL

1. Loosen the 2 screws retaining the front panel at the bottom.
2. Release catches at underside of the front panel by pulling downwards.
- 3a. Pull the underside of the front panel forward then lift upwards to remove.

#### REPLACEMENT

3. Engage the top of the front panel on the locating lugs and push the panel back into position engaging the securing screws
4. Re-tighten the securing screws.

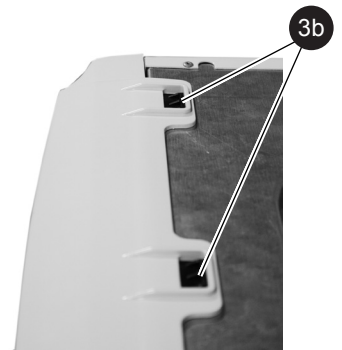
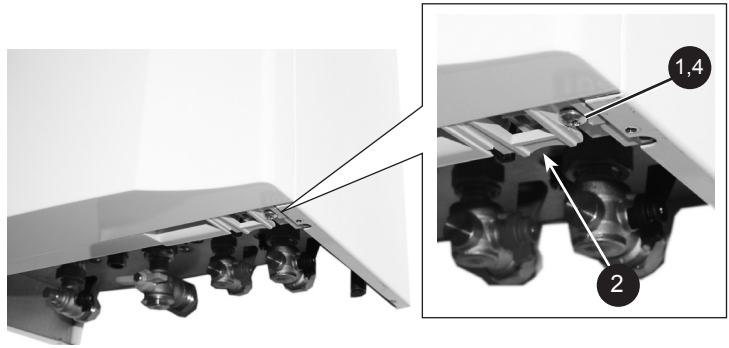

### 3.3 LOWERING THE CONTROLS PANEL / ACCESSING MAINS WIRING

1. Once the front panel has been removed the controls panel can be hinged down to access the wiring and electronics or the internal components of the boiler.
2. To lower the panel further (position 2) squeeze the 2 clips inward and hinge the panel into a lower position.
3. To gain access to the mains wiring connections, remove the retaining screw, press the retaining lug to the left and lift off the cover.

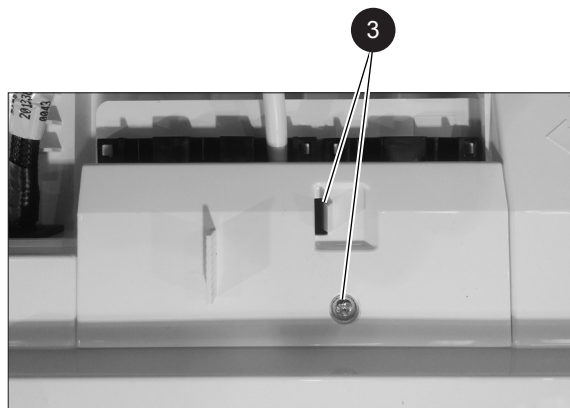
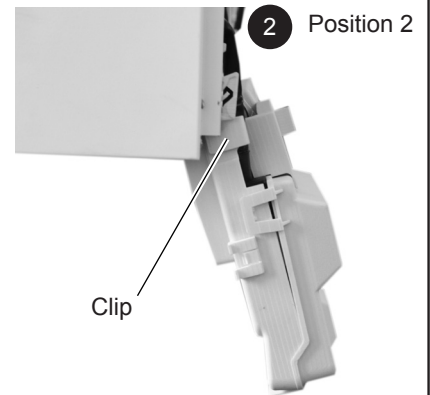
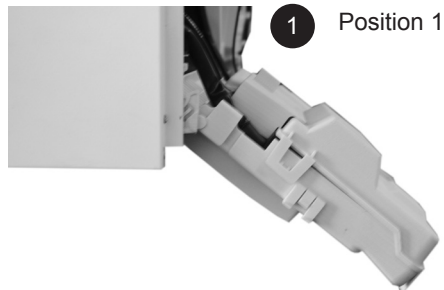

### 3.4 FAN AND VENTURI ASSEMBLY REMOVAL AND CLEANING

1. Refer to Sections 3.2 & 3.3.
2. Remove the ignition, detection and earth leads.
3. Remove the 2 clips securing the gas inlet pipe and remove the pipe.
4. Remove the fan low voltage and mains connections.
5. Remove the 4 securing nuts retaining the burner/fan assembly.
6. Remove the assembly from the heat exchanger.
7. To remove the venturi release the 2 securing screws to gain access for cleaning.
8. When replacing check the sealing gasket is undamaged or replace as necessary, and secure with the 2 screws.

\*Note a noise damper is fitted to the venturi inlet on 32 & 40 kW models.

9. To remove the fan, first remove the venturi as above and release the 3 screws securing the fan to the burner. (Note a mounting spacer is fitted to the fan outlet on 40 model only)
10. Remove the fan from the burner assembly. When replacing check the sealing gasket is undamaged or replace as necessary, and secure with the 3 screws.

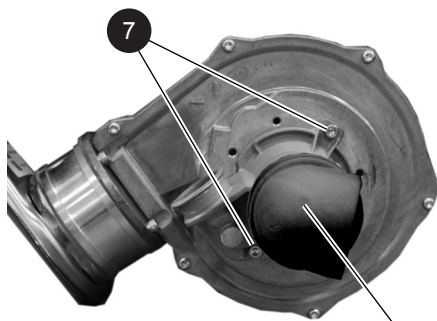
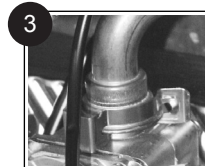
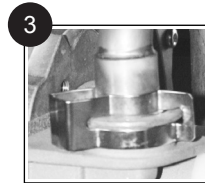
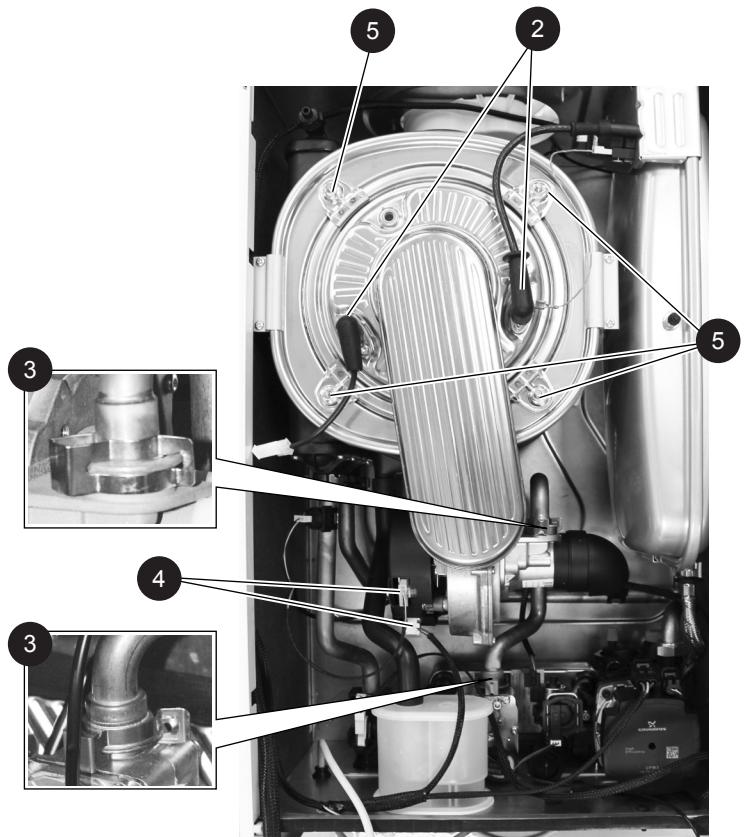

Noise Damper  
Fitted only to 40kW & 32kW models

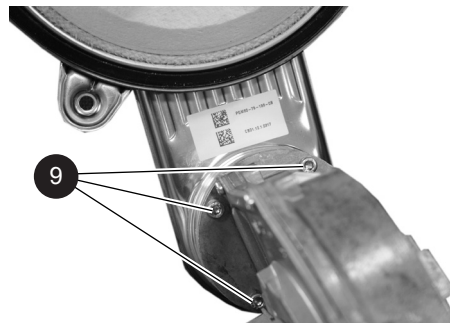

Mounting Spacer  
Fitted only to 40kW Model

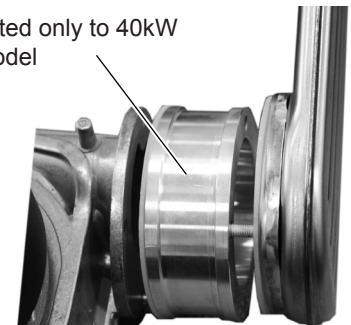

### 3.5 REMOVAL OF INJECTOR

1. Refer to Sections 3.2 & 3.3.
2. Remove the 2 clips securing the gas inlet pipe and remove the pipe, refer to Section 3.4.
3. Carefully ease the injector out of the gas valve.
4. Examine or clean as necessary.
5. Re-fit in reverse order ensuring the sealing o ring is in good condition or replace if necessary.
6. Refit the gas pipe ensuring the seals are in good condition and correctly located & secure with clips.

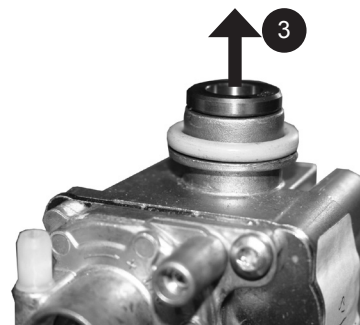

### 3.6 BURNER REMOVAL AND CLEANING

1. Refer to Sections 3.2 & 3.3
2. To remove Fan, Burner and Venturi Assembly refer to Section 3.4.
3. Remove the assembly from the heat exchanger.
4. Brush off any deposits with a SOFT brush.
- 5a. Inspect the burner door sealing gaskets and insulation for signs of damage. Replace as necessary.

The seal should be checked and replaced if showing any signs of degradation:

- Surface imperfections
- Cracks
- Discolouration
- Whitening

#### Replacement of burner door sealing gasket

- 5b. Remove the silicon seal from around the burner door location groove.
6. Re-new the seal and replace in reverse order.

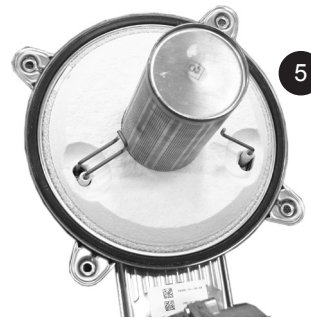
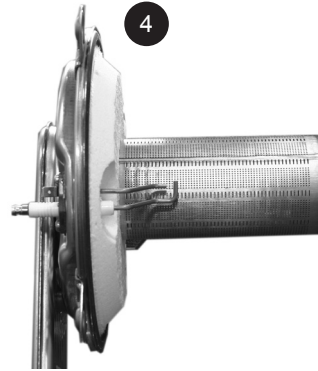

### 3.7 CLEANING THE CONDENSATE TRAP / SIPHON

1. Refer to Sections 3.2 & 3.3.
2. Remove the rubber condensate pipe from the top of the trap.
3. Rotate the trap clockwise to disengage the trap and lift clear of the outlet connection.
4. Flush out any debris under running water, and leave the trap half full of water.
5. Refit in reverse order making sure the trap is engaged with the outlet connection.
6. Re-position CH water pressure switch.

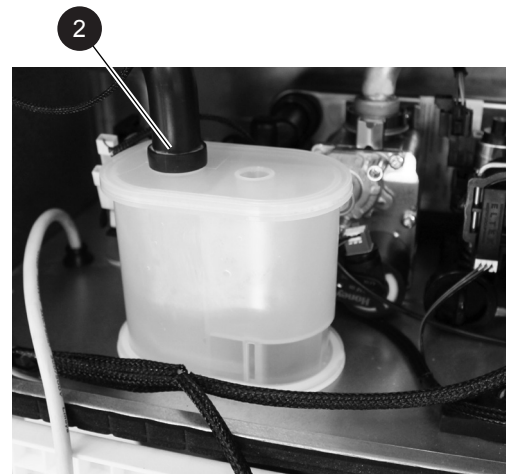

### 3.8 CLEANING THE HEAT EXCHANGER

1. Refer to Sections 3.2 & 3.3.
2. Remove Fan, Burner and Venturi Assembly. Refer to Section 3.4.
3. Once the front of the heat exchanger is open, the heat exchanger may be cleaned with a hand brush and vacuum cleaner to remove any debris.
4. Refit in reverse order.

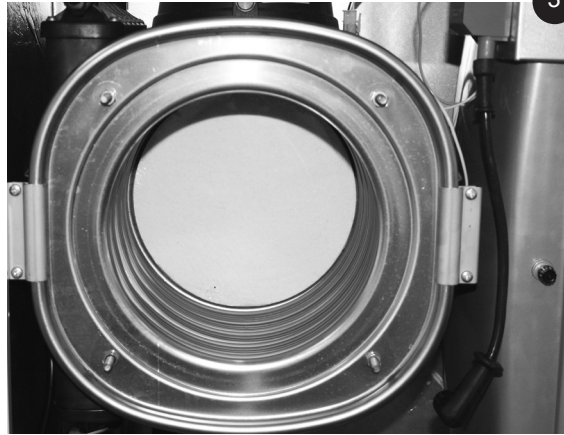

### 3.9 RE-ASSEMBLY

1. Reassemble the boiler in the following order:
2. Ensure the condensate trap is engaged in the base of the boiler and connected to the outlet with the pipe from the heat exchanger connected.
3. Refit the fan to the burner assembly. Refer to Section 3.4.
4. Refit the venturi to the fan and burner assembly. Refer to Section 3.4.
5. Refit the burner / fan / venturi assembly into the heat exchanger and secure. Refer to Section 3.4.
6. Refit the gas pipe and secure with the 2 clips. Refer to Section 3.4.
7. Reconnect the ignition / detection / earth / fan leads.
8. Swing the control panel back into its working position. Refer to Section 3.3.
9. Refit the front panel ensuring that a good seal is made. Refer to Section 3.2.
10. Turn on the gas supply at the gas service cock. Refer to Section 2.25.
11. Reconnect the electrical supply.
12. Check the operation of the boiler. Refer to Sections 2.24 - 2.27.

## SECTION 3 - SERVICING

### 3.10 REPLACEMENT OF COMPONENTS

When replacing ANY component:

1. Isolate the electrical supply
2. Isolate the water connections
3. Turn off the gas supply
4. Remove the front panel
5. Swing the control panel down into the service position

After replacing ANY component check operation of the boiler, including gas tightness, gas rate and combustion test.

#### **IMPORTANT.**

Ensure all gas valve connections are gas tight with a gas soundness check up to the gas control valve.

*When work is complete, the front panel must be correctly refitted - ensuring that a good seal is made.*

**THE BOILER MUST NOT BE OPERATED WITHOUT THE FRONT PANEL FITTED.**

### 3.11 FAN REPLACEMENT

1. Refer to Sections 3.2 & 3.3.
2. Remove the ignition, detection and earth leads.
3. Remove the 2 clips securing the gas inlet pipe and remove the pipe.
4. Remove the fan, low voltage and mains connections.
5. Remove the 4 securing nuts retaining the burner/fan assembly.
6. Remove the assembly from the heat exchanger.
7. To remove the venturi release the 2 securing screws to gain access for cleaning.
8. When replacing check the sealing gasket is undamaged or replace as necessary, and secure with the 2 screws.
9. To remove the fan, first remove the venturi as above and release the 3 screws securing the fan to the burner. (Note a mounting spacer is fitted to the fan outlet on 40kW model only)
10. Replace the fan and refit the venturi checking the sealing gasket is undamaged or replace as necessary, and secure with the 2 screws
11. Check the operation of the boiler. Refer to Sections 2.24 - 2.27.

*\*Note a noise damper is fitted to the venturi inlet on 40kW and 32kW models*

*\*Note a mounting spacer is fitted to the fan outlet on 40kW.*

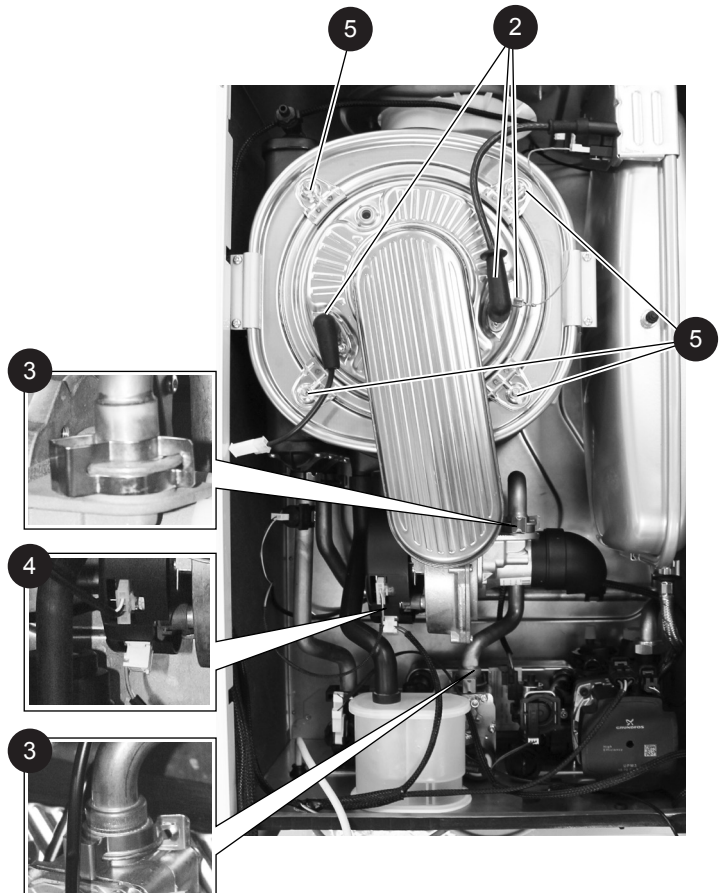

Mounting Spacer

Fitted only to  
40kW model

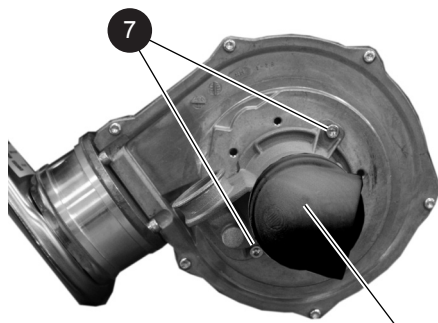

Noise Damper

Fitted only to 40kW &  
32kW models

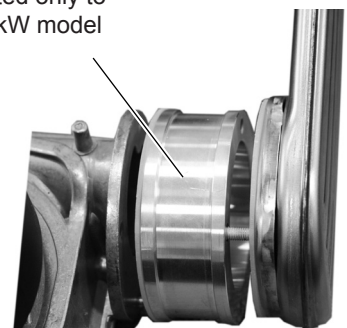
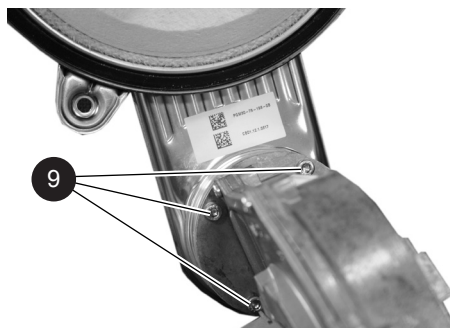

### 3.12 BURNER INJECTOR REPLACEMENT

1. Refer to Sections 3.2 to 3.4.
2. Remove the 2 clips securing the gas inlet pipe and remove the pipe.
3. Carefully ease the injector out of the gas valve.
4. Replace injector 'O' ring.
5. Re-fit in reverse order ensuring the sealing o ring is in good condition or replace if necessary.
6. Refit the gas pipe ensuring the seals are in good condition and correctly located.
7. Secure with the clips.
8. Check the operation of the boiler. Refer to Sections 2.24 to 2.27.

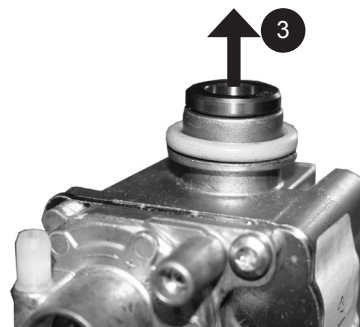

### 3.13 BURNER/DOOR ASSEMBLY REPLACEMENT

1. Refer to Sections 3.2 to 3.4.
2. Remove the ignition, detection and earth leads.
3. Remove the 2 clips securing the gas inlet pipe and remove the pipe.
4. Remove the fan leads.
5. Remove the 4 securing nuts retaining the burner/door/fan assembly.
6. Remove the assembly from the heat exchanger.
7. To remove the venturi release the 2 securing screws.
8. To remove the fan release the 3 screws securing the fan to the burner/door assembly.
9. Remove the ignition and detection probes.
10. Refit the fan, venturi, ignition probe and detection probe to the new burner/door assembly.
11. Refit in reverse order.
12. Check the operation of the boiler. Refer to Sections 2.24 to 2.27.

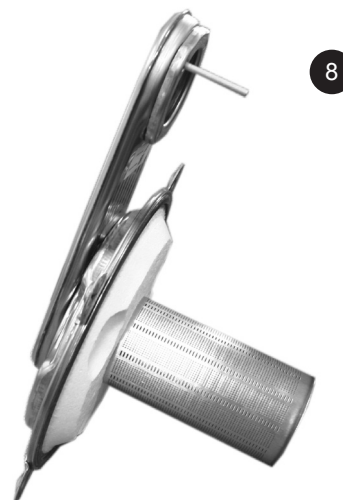

### 3.14 RETURN THERMISTOR RENEWAL

1. Refer to Sections 3.2 to 3.3.
2. Unclip the return thermistor.
3. Disconnect the electrical lead from the thermistor.
4. Reconnect the electrical lead to the new thermistor and reassemble in reverse order, ensuring that the thermistor is securely fitted to the pipe on the thermistor locator tabs as shown.
5. Check the operation of the boiler. Refer to Sections 2.24 to 2.27.

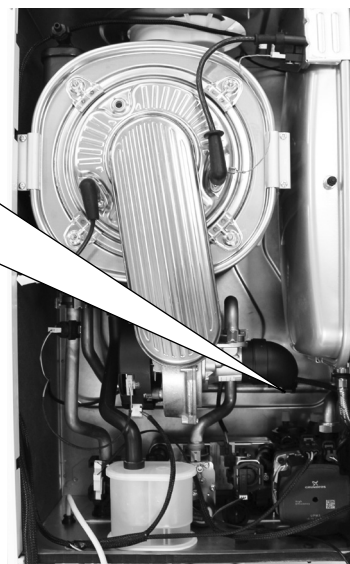
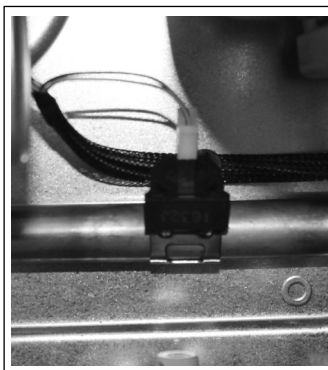

### 3.15 IGNITION ELECTRODE REPLACEMENT

1. Refer to Sections 3.2 & 3.3.
2. Disconnect the ignition lead and the earth connection.
3. Release the 2 securing screws and carefully withdraw the probe.
4. Check the gap on the replacement ignition electrode is  $4.5 \pm 0.5$ mm.
5. Ensure the sealing gasket is fitted and in good condition.
6. Carefully feed the electrode into the burner/door assembly and secure with the 2 screws ensuring correct orientation.
7. Reconnect the ignition lead and earth.
8. Check the operation of the boiler. Refer to Sections 2.24 to 2.27.

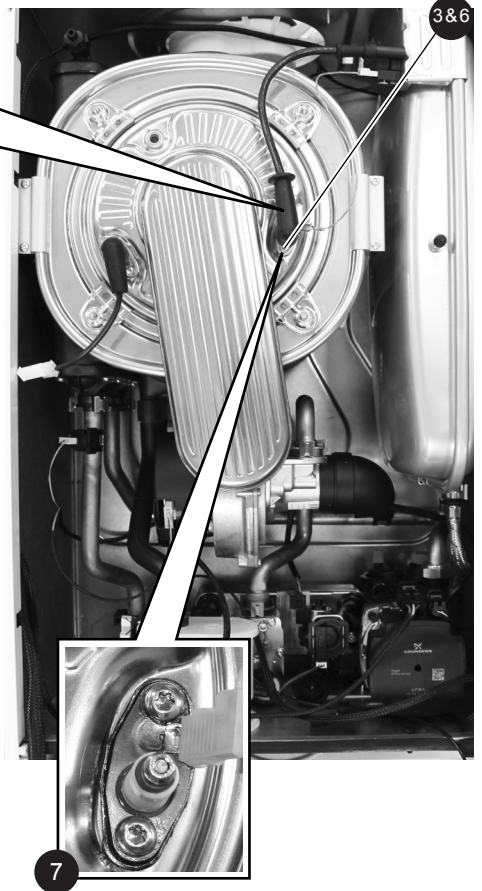
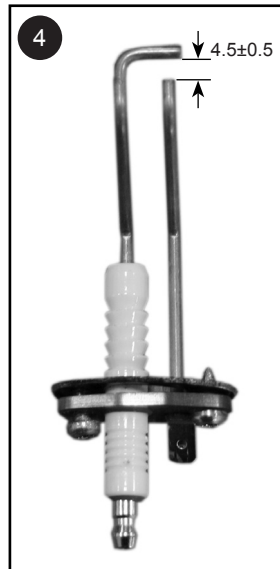

### 3.16 FLAME DETECTION ELECTRODE REPLACEMENT

1. Refer to Sections 3.2 & 3.3.
2. Disconnect the detection lead.
3. Release the 2 securing screws and withdraw the probe.
4. Ensure the sealing gasket is fitted to the replacement electrode and in good condition.
5. Carefully feed the electrode into the burner/door assembly and secure with the 2 screws ensuring correct orientation.
6. Reconnect the detection lead.
7. Check the operation of the boiler. Refer to Sections 2.24 to 2.27

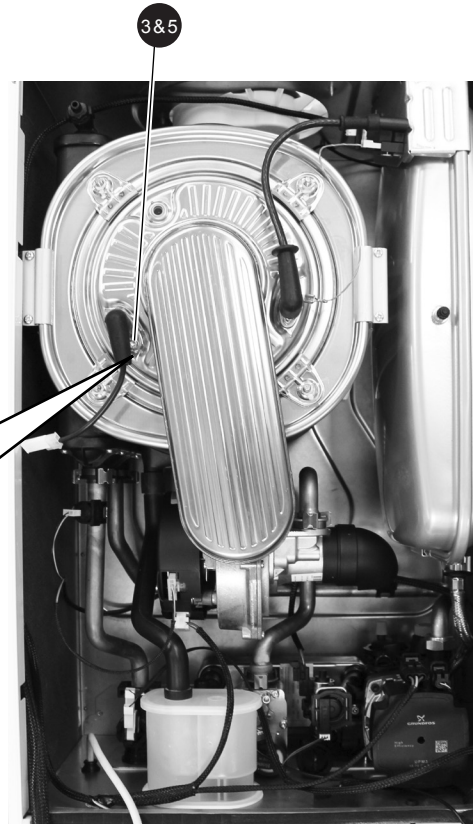
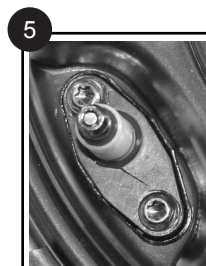



### 3.17 SPARK GENERATOR REPLACEMENT

1. Refer to Sections 3.2 & 3.3.
2. Disconnect the leads from the spark generator.
3. Remove spark generator by pulling forwards to release the retaining clip, then push back to release the second retaining clip.
4. Fit the new spark generator and re-assemble in reverse order ensuring that the the earth lead is replaced.
5. Check the operation of the boiler. Refer to Sections 2.24 to 2.27.

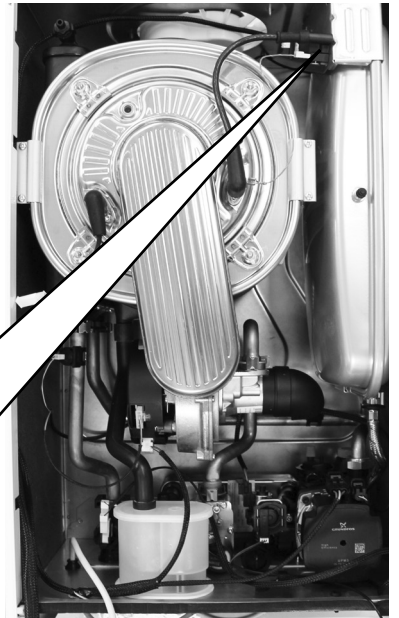
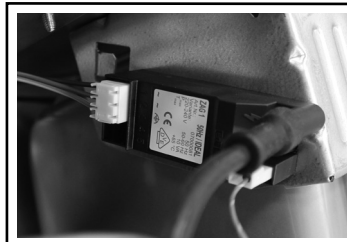

### 3.18 GAS CONTROL VALVE REPLACEMENT

1. Refer to Sections 3.2 & 3.3.
2. Remove the gas inlet pipe. Refer to Section 3.4.
3. Unplug the electrical connection.
4. Disconnect the gas service cock, refer to Section 2.25.
5. Remove the 2 securing screws in the underside of the boiler casing and remove the valve.
6. Remove brass injector from gas valve outlet and re-fit into replacement valve.
7. Replace in reverse order ensuring all seals are in good condition and the assembly is gas sound.
8. Ensure all gas valve connections are gas tight with a gas soundness check up to the gas control valve.
9. Check the operation of the boiler. Refer to Sections 2.24 to 2.27.

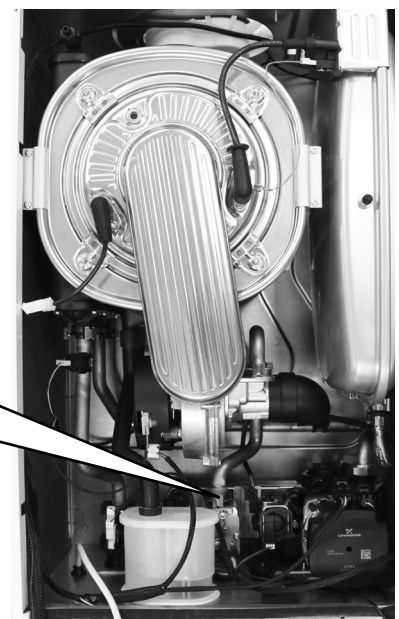
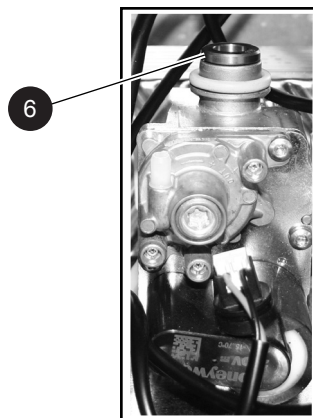

### 3.19 DIVERTER VALVE ACTUATOR REPLACEMENT

1. Set the Diverter Valve to mid position, using the boiler controls. Refer to page 47 (3 WAY VALVE MIDPOSITION).
2. Refer to Sections 3.2 & 3.3.
3. Disconnect the electrical cable connection on the diverter valve actuator.
4. Place a flat bladed screwdriver in the actuator slot provided and ease out the actuator.
5. Lift the valve actuator clear of the valve body.
6. Fit the new motor ensuring the arm is correctly engaged in the metal fork and re-assemble in reverse order.
7. Check the operation of the boiler. Refer to Sections 2.24 to 2.27.

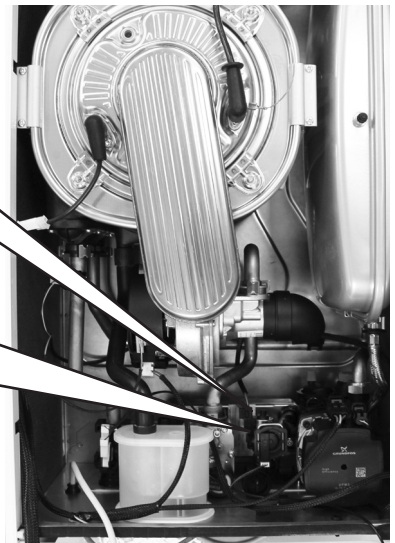
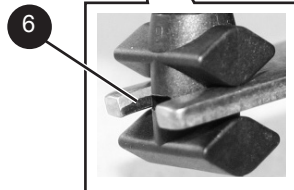
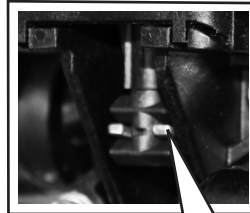
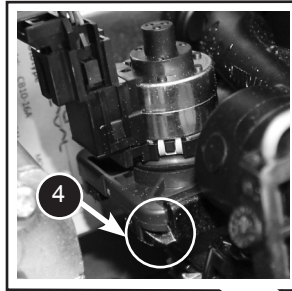

### 3.20 CONDENSATE TRAP REPLACEMENT

1. Refer to Sections 3.2 & 3.3.
2. Remove the rubber condensate pipe from the top of the trap.
3. Rotate the trap clockwise to disengage the trap and lift clear of the outlet connection.
4. Replace the trap and refit in reverse order making sure the trap is engaged with the outlet connection.
5. Refill the condensate trap.
6. Check the operation of the boiler. Refer to Sections 2.24 to 2.27.

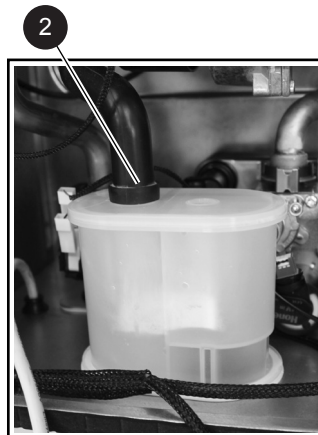

## 3.21 PCB REPLACEMENT

**Note.** Fit the earth strap provided with the PCB to your wrist and secure to a suitable earth on the boiler chassis.

1. Refer to Sections 3.2 & 3.3.
2. Remove the 2 screws securing the controls housing lid.
3. Remove the electrical cover at the clips.
4. Carefully disconnect all electrical connectors.
5. Remove PCB from mounting posts by releasing the 3 clips.
6. Take new PCB and reconnect all plug connections.
7. Re-assemble in reverse order.
8. Turn power on and follow the on screen instructions as shown:

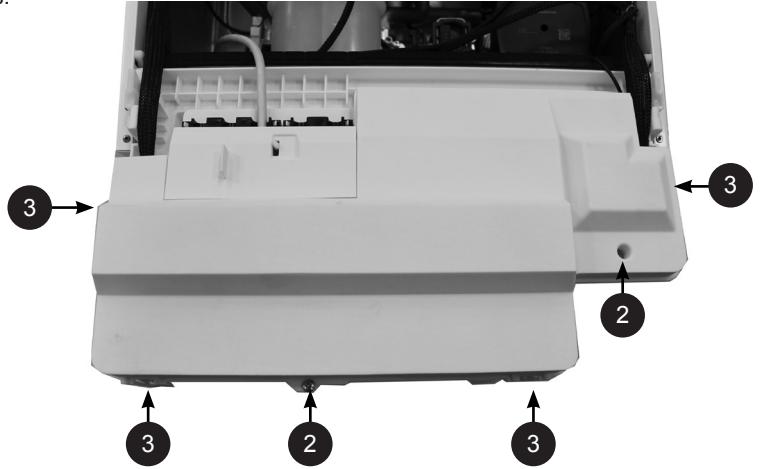

Press YES

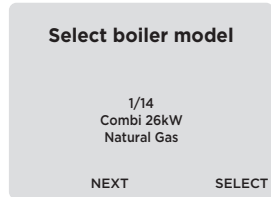
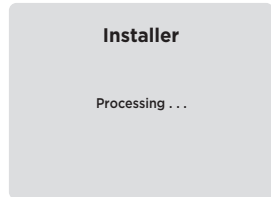
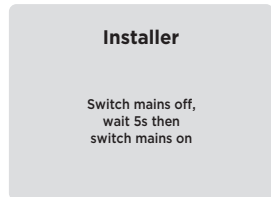

\* Press NEXT until the desired boiler output and gas type is displayed. Then press SELECT

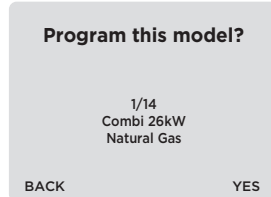

Press YES to confirm.

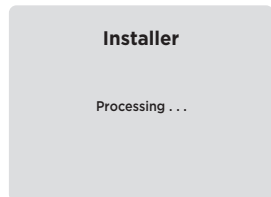

The PCB will reset and the following screen will be shown.

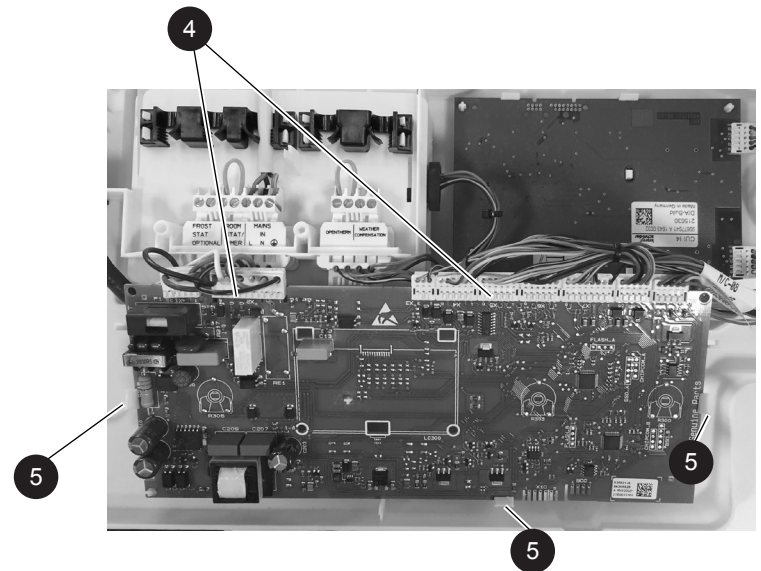

**\* IMPORTANT.** IT IS CRITICAL FOR SAFE OPERATION THAT THE CORRECT BOILER SIZE AND FUEL TYPE IS ENTERED INTO THE BOILER.

## SECTION 3 - SERVICING

### 3.22 USER PCB REPLACEMENT

1. Set both the user temperature selector knobs to the 12 o'clock position.
2. Refer to Sections 3.2 & 3.3.
3. Remove the two screws securing the controls housing lid. Refer to Section 3.21.
4. Remove the electrical cover at the clips indicated. Refer to Section 3.21.
5. Disconnect the 2 electrical connectors carefully.
6. Remove PCB from mounting posts by releasing the 4 clips.
7. Replace the PCB and refit in reverse order.
8. Check the operation of the boiler. Refer to Sections 2.24 to 2.27.

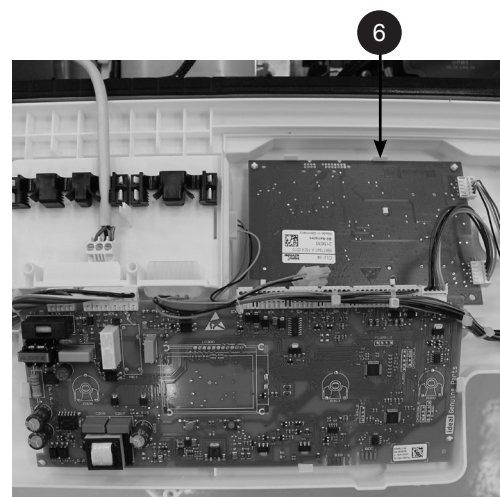
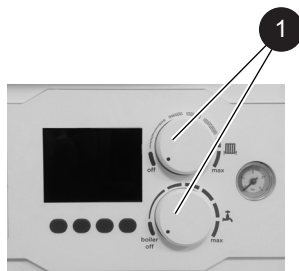

### 3.23 DHW FLOW TURBINE SENSOR REPLACEMENT

1. Refer to Sections 3.2 & 3.3.
2. Drain the DHW system. Refer to Section 3.24.
3. Pull off and remove the retaining clip.
4. Use the clip to ease the turbine sensor from its housing.
5. Re-assemble in reverse order.
6. Check that the boiler operates in both DHW & CH modes. Refer to Sections 2.24 to 2.27.

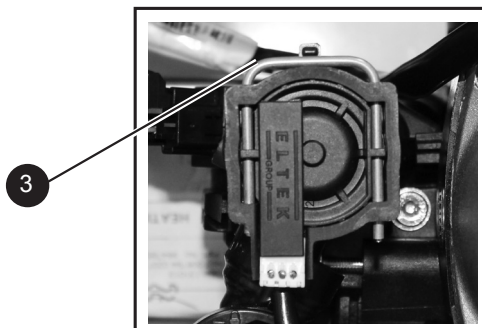

### 3.24 DRAINING THE BOILER

#### CENTRAL HEATING CIRCUIT

1. Close all the CH water isolating valves on the boiler inlet.
2. To drain the primary heat exchanger circuit: Open the drain point by unscrewing using a flat blade screw driver and attach a length of drain hose.
3. After replacing any component on the boiler, remove the hose, close the drain valve and open all system isolating valves (re-pressurise as appropriate by re-connecting the filling loop, refer to Section 2.15) before proceeding to check operation of the boiler.
4. Disconnect filling loop. Refer to Section 2.15.
5. Check operation of the boiler. Refer to Sections 2.24 to 2.27.

#### DOMESTIC HOT WATER CIRCUIT

1. Close the DHW water isolating valve on the DHW inlet.
2. To drain the domestic hot water circuit: As there is no direct drain for the domestic hot water circuit, depending on the location of the boiler, opening the lowest hot water tap may drain this circuit. However it must be noted that some residual water will be experienced during replacement of components.
3. After replacing any component on the boiler open the DHW inlet isolating valve and vent the DHW system by opening all hot taps and ensuring water flows from each tap.
4. Disconnect filling loop. Refer to Section 2.15.
5. Check operation of the boiler. Refer to Sections 2.24 to 2.27.

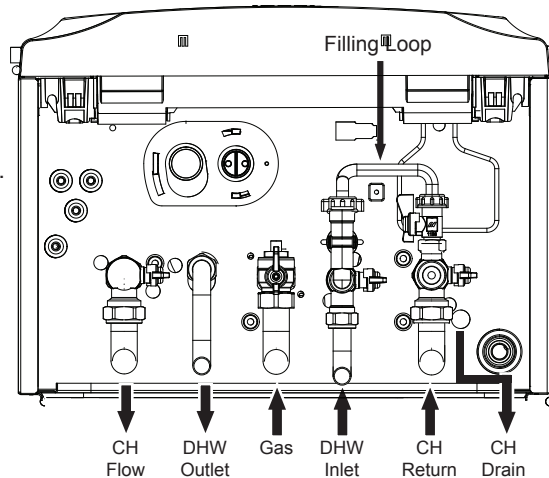

### 3.25 PRESSURE GAUGE RENEWAL

1. Refer to Sections 3.2 & 3.3.
2. Close the isolating service valves and drain the (CH) boiler. Refer to Section 3.24.
3. Remove the clip retaining the pressure sensor capillary.
4. Remove the pressure sensor capillary.
5. Remove the two screws securing the controls housing lid. Refer to Section 3.21.
6. Remove the electrical cover at the clips indicated. Refer to Section 3.21.
7. Release the clip retaining the pressure gauge and remove the gauge, drawing the capillary carefully through the rubber grommet and out of the boiler.
8. Refit in reverse order. Refill the CH system. Refer to Section 2.15.
9. Check the operation of the boiler. Refer to Sections 2.24 to 2.27.

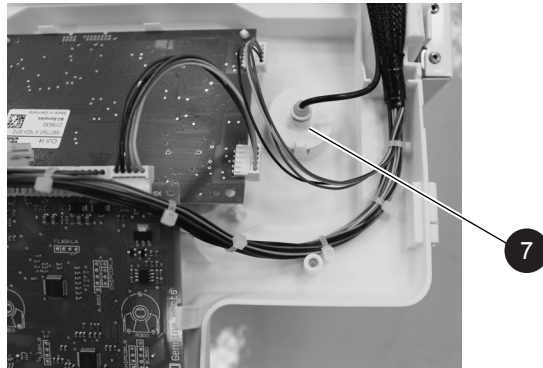
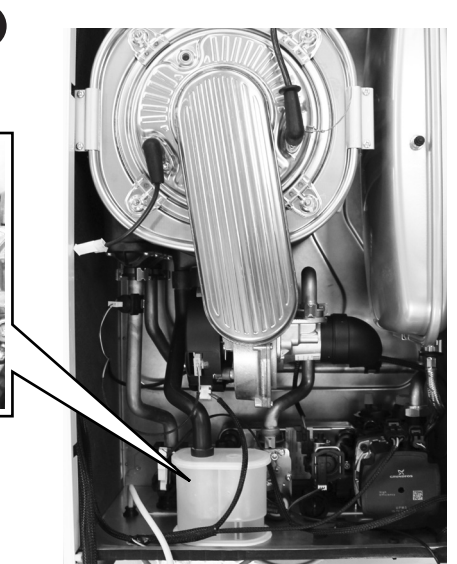
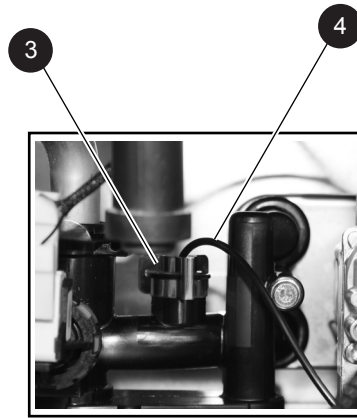

### 3.26 SAFETY RELIEF VALVE RENEWAL

1. Refer to Sections 3.2 & 3.3.
2. Close the isolating service valves and drain the (CH) boiler. Refer to Section 3.24.
3. Remove the burner & Fan assembly, if required for access. Refer to Section 3.4.
4. Undo the Safety Relief Valve outlet retaining nut. (retaining the washer)
5. Remove the securing clip at the rear of the valve body.
6. Withdraw the valve vertically.
7. Renew the valve and refit in reverse order.
8. Refill the CH system. Refer to Section 2.15.
9. Check the operation of the boiler. Refer to Sections 2.24 to 2.27.

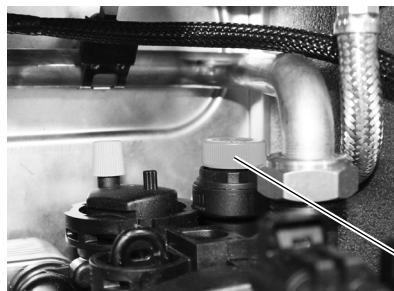

### 3.27 PUMP AUTO AIR VENT REPLACEMENT

1. Refer to Sections 3.2 & 3.3.
2. Close the isolating service valves and drain the (CH) boiler. Refer to Section 3.24.
3. Remove the burner & Fan assembly, if required for access. Refer to Section 3.4.
4. The auto air vent is retained in the pump body with a bayonet connection. The air vent and float assembly is removed by turning the head anti-clockwise (viewed from above) and pulling upwards.
5. Ensure the air vent head o ring seal is in place when refitting and the seal is in place at the pump outlet connection.
6. Reassemble in reverse order.
7. Refill the CH system. Refer to Section 2.15.
8. Loosen the cap of the air vent.
9. Check the operation of the boiler. Refer to Sections 2.24 to 2.27.

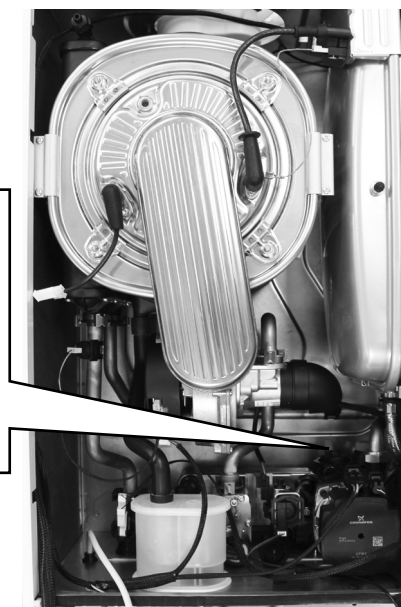
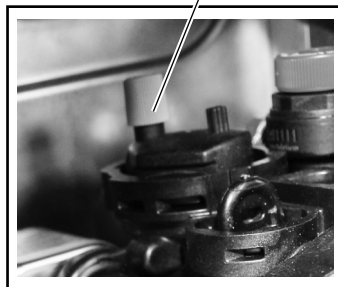

### 3.28 DIVERTER VALVE BODY ASSEMBLY REPLACEMENT

To remove the valve body assembly:

1. Refer to Sections 3.2 & 3.3.
2. Drain the boiler. Refer to Section 3.24.
3. Remove the condensate trap/siphon. Refer to Section 3.20.
4. Remove the electrical plug from the diverter valve actuator. Refer to Section 3.19.
5. Place a flat bladed screwdriver in the diverter valve motor body slot provided and ease out the motor. Refer to Section 3.19.
6. Remove the return thermistor electrical connection. Refer to Section 3.14.
7. Remove the pump electrical connections. Refer to Section 3.30.
8. Remove DHW Turbine electrical connection. Refer to Section 3.23.
9. Remove the DHW plate heat exchanger (note orientation). Refer to Section 3.29.
10. Undo the safety valve pipe. Refer to Section 3.26.
11. Loosen the nut above pump and remove the clip at the heat exchanger end of the return pipe. Remove the return pipe.
12. Unclip and pull out the expansion vessel connection hose from the expansion vessel. Refer to Section 3.35.
13. Remove the DHW inlet and CH return connection situated beneath the boiler.
14. Remove the four torx head screws fixing the return manifold to the boiler sheet steel base.
15. Lift the manifold assembly and remove from boiler.

16. Twist and remove the DHW manifold.
17. Remove the two diverter valve body fixing screws and withdraw the diverter valve body assembly.
18. Fit the new diverter valve body assembly and replace the two fixing screws.
19. Refit the DHW manifold, fit the assembly back to the boiler and reassemble in reverse order.
20. Refill the boiler.
21. Check the operation of the boiler. Refer to Sections 2.24 to 2.27.

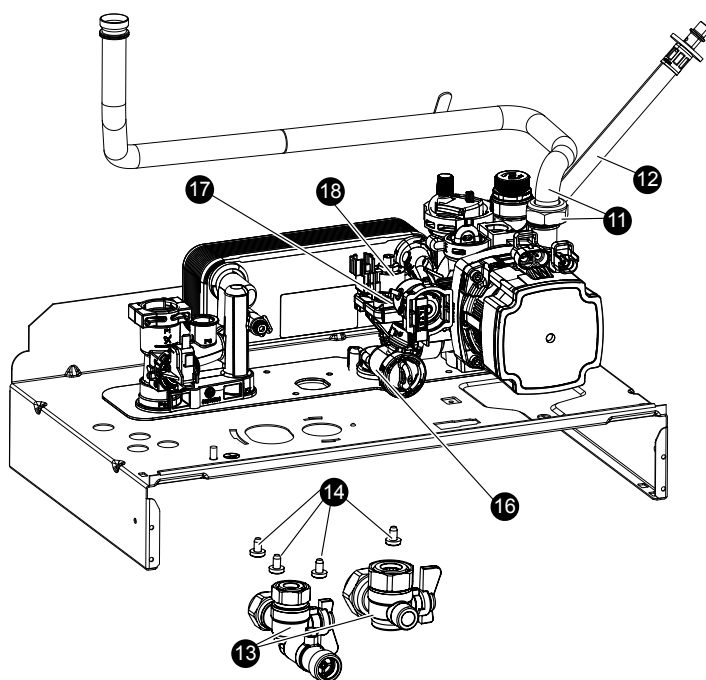

### 3.29 DHW PLATE HEAT EXCHANGER REPLACEMENT

1. Refer to Sections 3.2 & 3.3.
2. Close the isolating service valves and drain the heating and DHW systems. Refer to Section 3.24.
3. Remove the condensate trap. Refer to Section 3.20.
4. Remove the 2 Allen screws securing the plate heat exchanger to the plastic housing.
5. Ease the plate heat exchanger back to disengage and lift out. Be aware of any water spillage.
6. Fit the new heat exchanger using the new o rings supplied.
7. **Note.** Ensure that the depressions are on the bottom prior to fitting.
8. Refit in reverse order.
9. Open the isolating service valves, refill the CH and DHW systems and vent as necessary. Refer to Section 2.15.
10. Check the operation of the boiler. Refer to Sections 2.24 to 2.27.

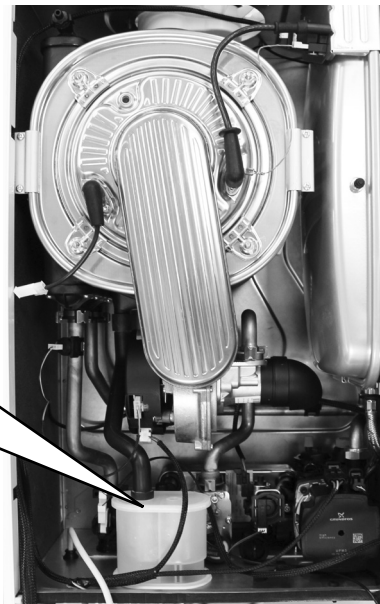
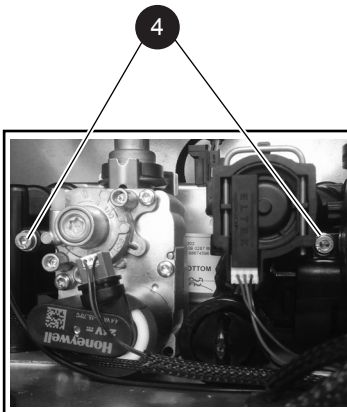

### 3.30 PUMP HEAD REPLACEMENT

1. Refer to Sections 3.2 & 3.3.
2. Close the isolating service valves and drain the (CH) boiler. Refer to Section 3.24.
3. Disconnect both electrical leads to the pump.
4. Remove the 4 Allen screws securing the pump head and remove.
5. Refit in reverse order.
6. Open the isolating valves and refill the CH system. Refer to Section 2.15.
7. Check the operation of the boiler. Refer to Sections 2.24 to 2.27.

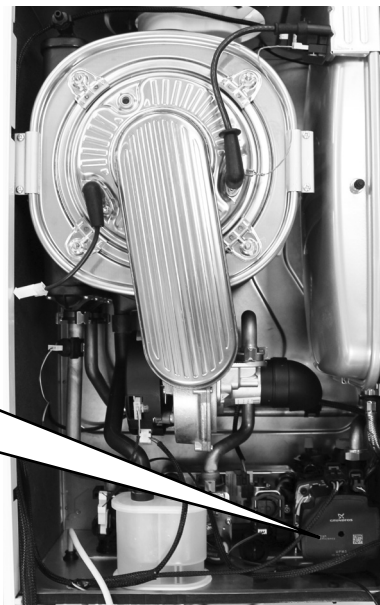
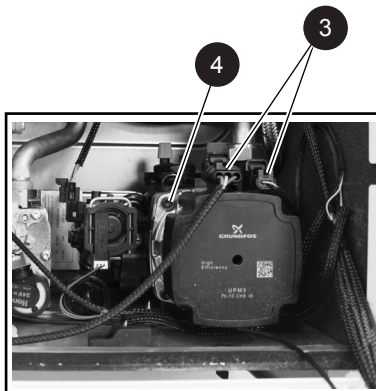

### 3.31 CH WATER PRESSURE SENSOR REPLACEMENT

1. Refer to Sections 3.2 & 3.3.
2. Close the isolating service valves and drain the (CH) boiler. Refer to Section 3.24.
3. Remove the condensate trap. Refer to Section 3.20.
4. Remove the retaining clip to the rear of the housing.
5. Pull out the sensor and disconnect the electrical connection.
6. Refit in reverse order.
7. Open the isolating valves and refill the CH system. Refer to Section 2.15.
8. Check the operation of the boiler. Refer to Sections 2.25 to 2.27.

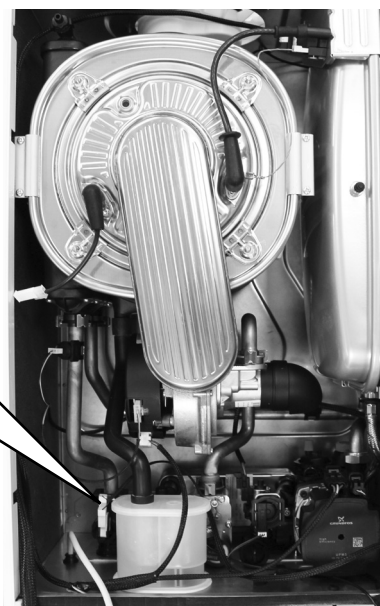
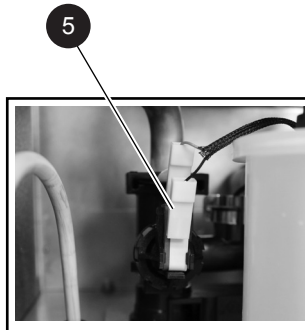

## SECTION 3 - SERVICING

### 3.32 DHW FILTER AND FLOW REGULATOR CLEANING/REPLACEMENT

1. Refer to Sections 3.2 & 3.3.
2. Drain the DHW system. Refer to Section 3.24.
3. Turn the housing anti clockwise and pull forward to remove the cartridge.
4. Using a pair of pliers, pull out the plastic filter/flow regulator.
5. Clean or replace filter as necessary.
6. Reassemble in reverse order.
7. Refill the boiler. Refer to Section 2.15.
8. Check the operation of the boiler. Refer to Sections 2.25 to 2.27.

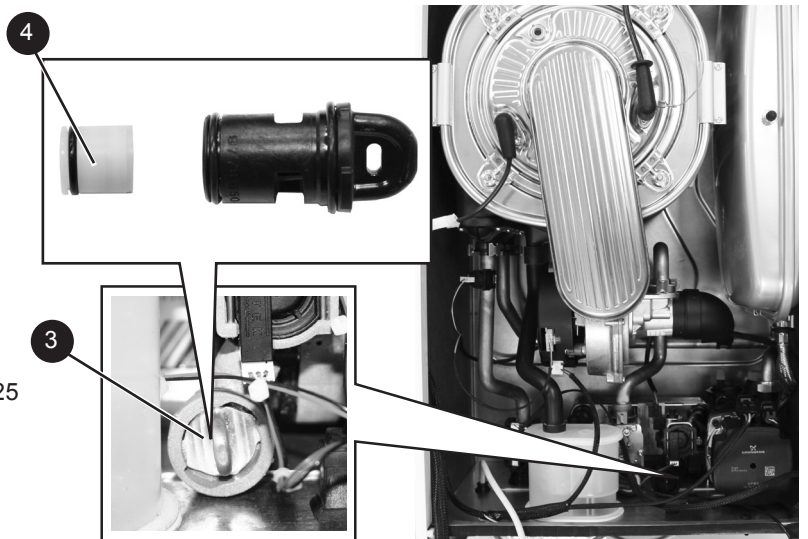

### 3.33 FLOW THERMISTOR REPLACEMENT

1. Refer to Sections 3.2 & 3.3.
2. Unclip the flow thermistor.
3. Disconnect the electrical lead from the thermistor.
4. Reconnect the electrical lead to the new thermistor and reassemble in reverse order, ensuring that the thermistor is securely fitted to the pipe on the thermistor locator tabs as shown.
5. Check the operation of the boiler. Refer to Sections 2.25 to 2.27.

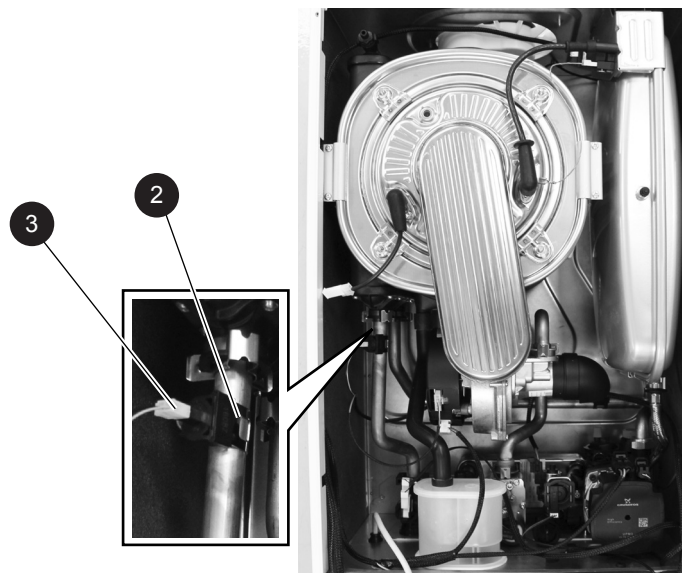



**3.34 HEAT EXCHANGER REPLACEMENT**

1. Refer to Sections 3.2 & 3.3.
2. Close the isolating service valves and drain the (CH) boiler. Refer to Section 3.24.
3. Remove the condensate trap. Refer to Section 3.20.
4. Remove the Burner & Fan assembly. Refer to Section 3.4.
5. Remove the securing clips to disconnect the flow and return pipes below the heat exchanger.
6. Disconnect the condensate pipe from the sump.
7. Disconnect the thermal fuse lead.
8. Remove the horseshoe bracket and lift up the flue turret.
9. Remove the securing screws and disconnect the flue outlet.
10. Remove the 4 screws securing the heat exchanger fixing brackets.
11. Remove the heat exchanger forwards, lifting to clear the flow and return pipes.
12. Refit in reverse order. Ensure all wires and harnesses are in their correct position in order to prevent damage to them.
13. Open the isolating valves and refill the CH system. Refer to Section 2.15.
14. Ensure all gas valve connections are gas tight with a gas soundness check up to the gas control valve.
15. Check the operation of the boiler. Refer to Sections 2.24 to 2.27.

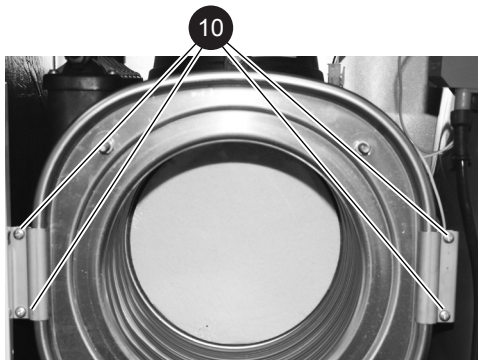
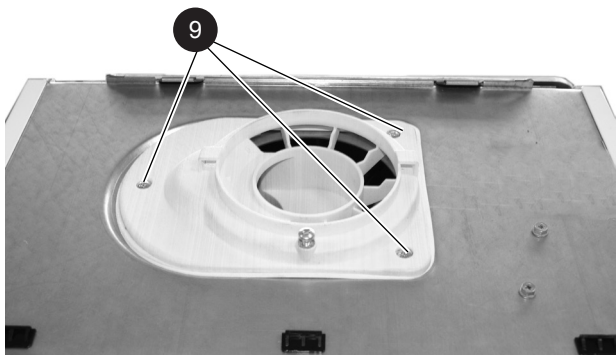
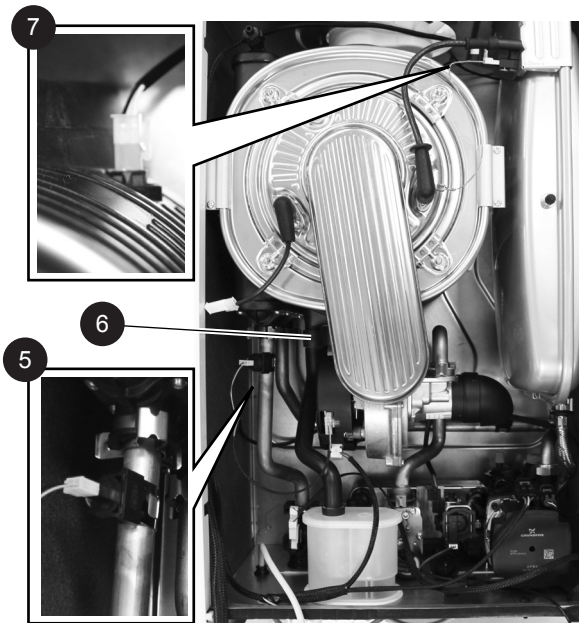

SERVICING

## SECTION 3 - SERVICING

### 3.35 EXPANSION VESSEL RECHARGING AND REPLACEMENT

#### Recharging:

- A. Refer to Sections 3.2 & 3.3.
- B. Remove the charge point dust cover.
- C. Recharge the tank pressure to 0.75bar
- D. Refit in reverse order
- E. Check the operation of the boiler. Refer to Sections 2.24 to 2.27.

#### Replacement:

1. Refer to Sections 3.2 & 3.3.
2. Close the isolating service valves and drain the (CH) boiler. Refer to Section 3.24
3. Remove the clip securing the flexible connecting hose and disconnect.
4. Remove the two securing screws from the top of the casing at the same time holding the ignitor bracket to prevent movement.
5. Hold the expansion vessel and move the ignition assembly bracket carefully to one side.
6. Pull the bottom of the expansion vessel forward, when free pull vessel downwards and remove.
7. Refit in reverse order.
8. Open the isolating valves and refill the CH system. Refer to Section 2.15.
9. Check the operation of the boiler. Refer to Sections 2.25 to 2.24.

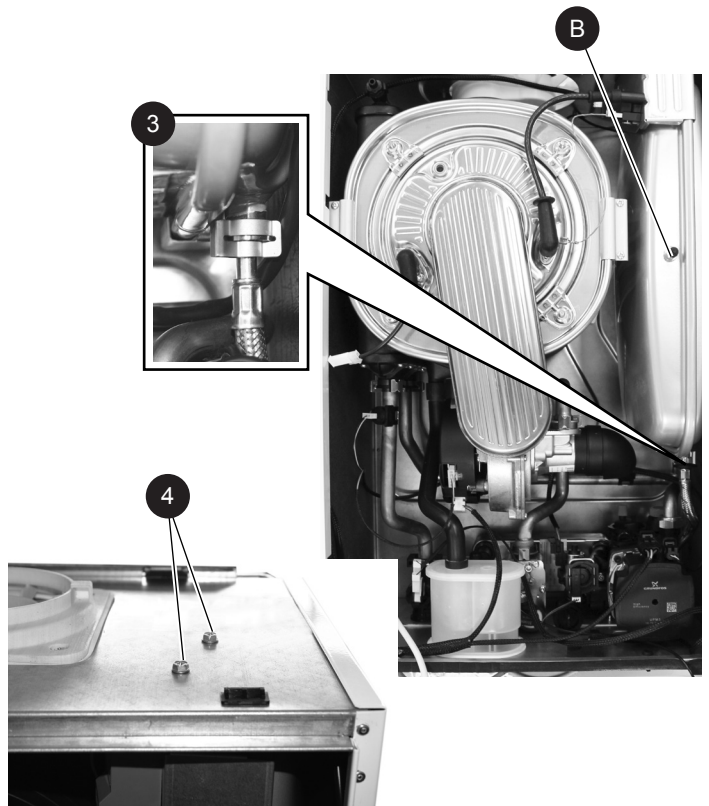

### 3.36 BOILER SEALING PANEL REPLACEMENT

1. Refer to Sections 3.2 & 3.3.
2. Remove the old seal from the casing.
3. Fit the new seal ensuring correct location over the fixing pins and the material is fully located within the casing.
4. Reassemble in reverse order.
5. Check the operation of the boiler. Refer to Sections 2.24 to 2.27.

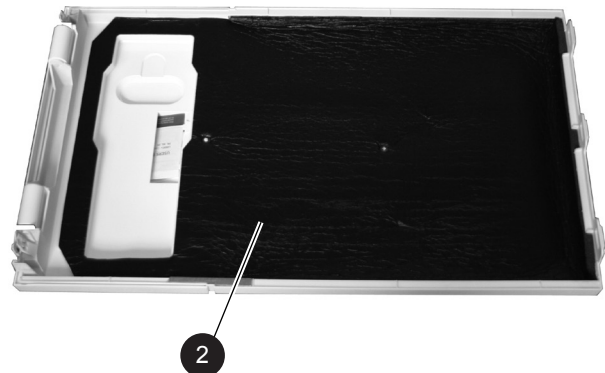

## SECTION 4 - FAULT FINDING

### 4.1 FAULT FINDING CHART MAIN MENU

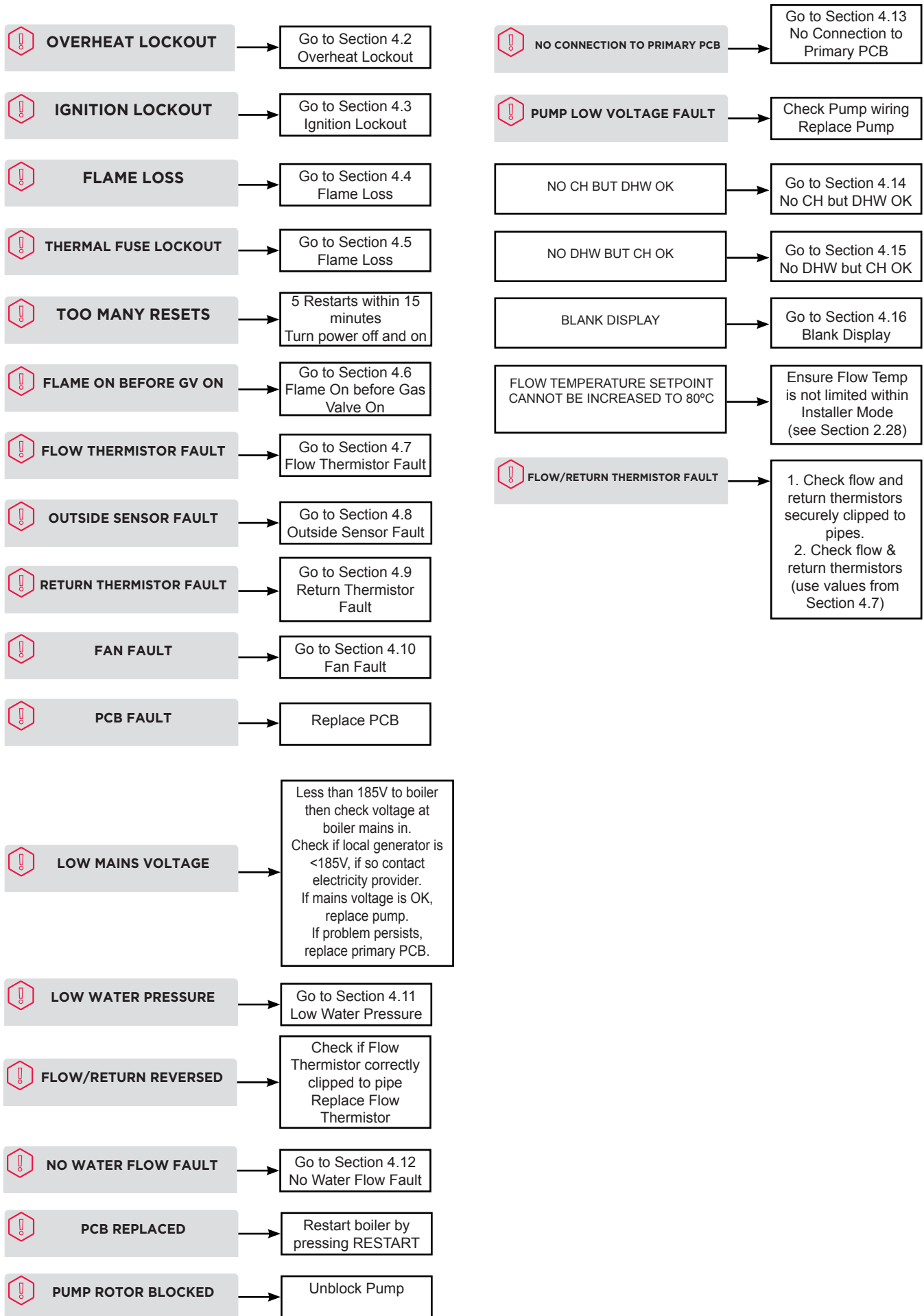

FAULT FINDING FAULT FINDING FAULT FINDING FAULT FINDING FAULT FINDING

## SECTION 4 - FAULT FINDING

### 4.2 OVERHEAT LOCKOUT

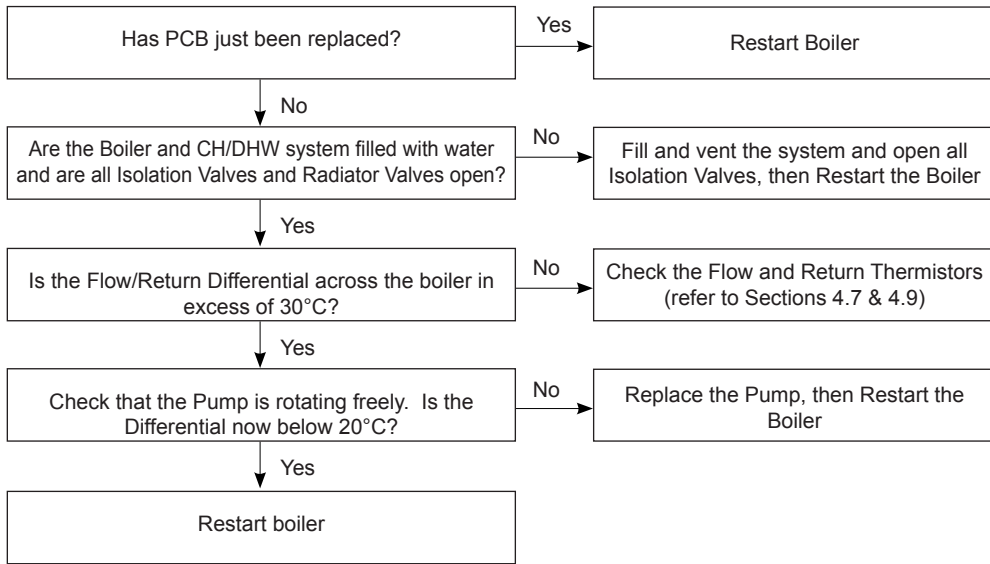

### 4.3 IGNITION LOCKOUT

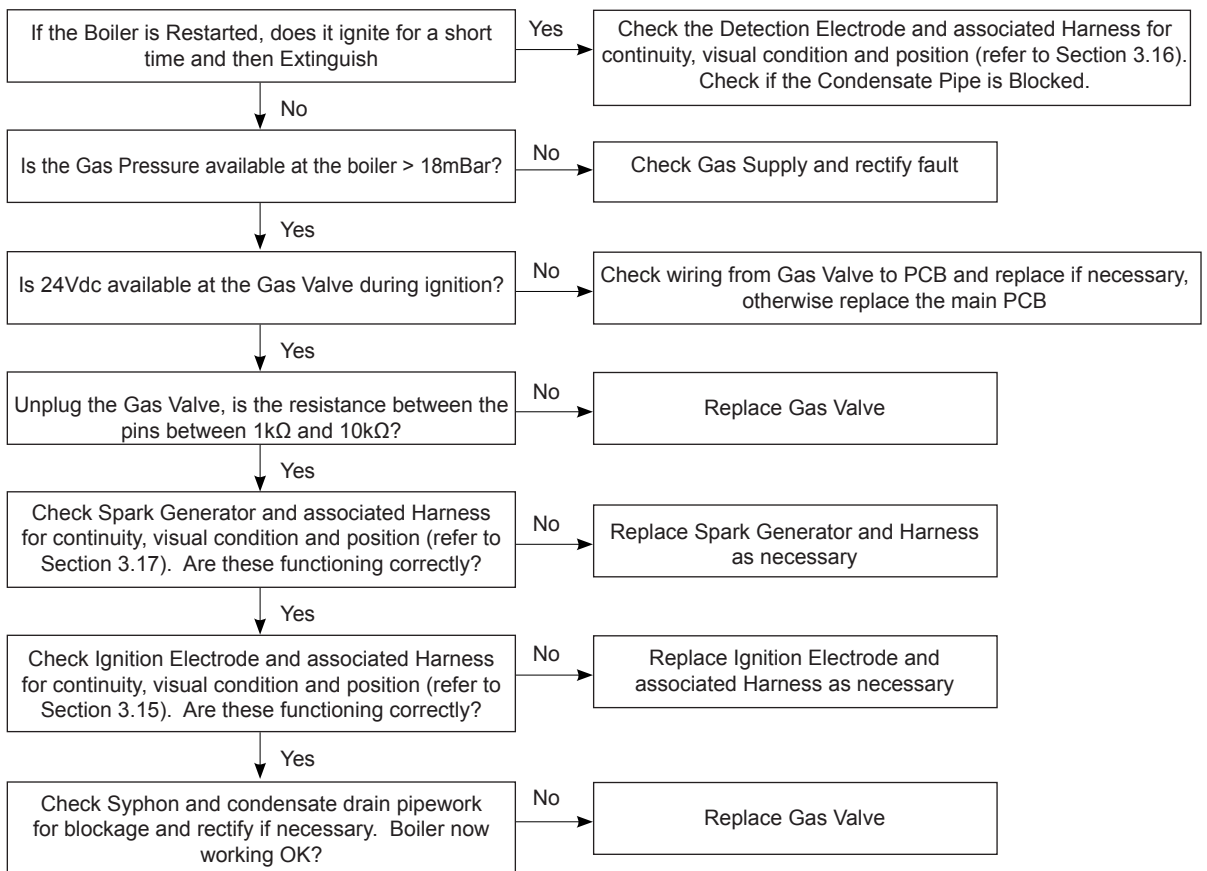

## SECTION 4 - FAULT FINDING

### 4.4 FLAME LOSS

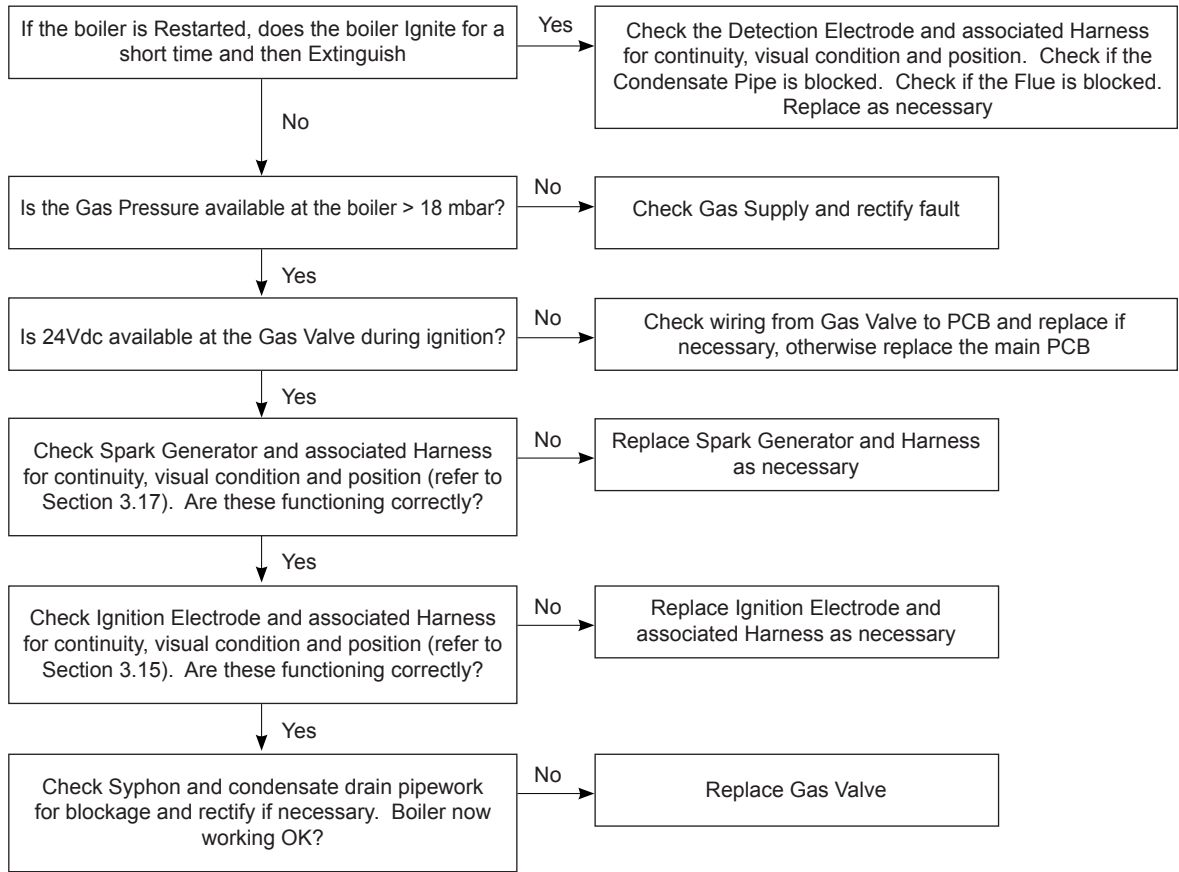

### 4.5 THERMAL FUSE LOCKOUT

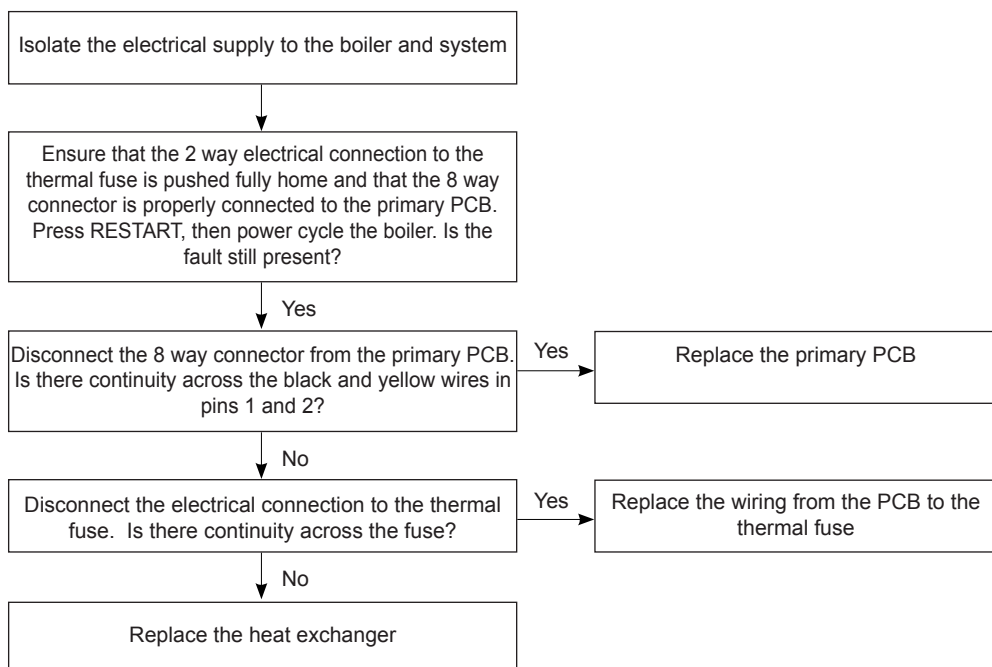

FAULT FINDING FAULT FINDING FAULT FINDING FAULT FINDING

## SECTION 4 - FAULT FINDING

### 4.6 FLAME ON BEFORE GAS VALVE ON

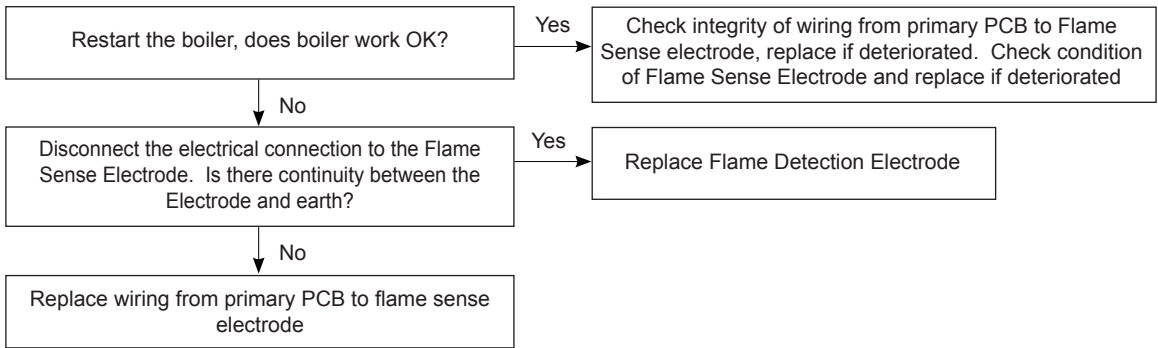

### 4.7 FLOW THERMISTOR FAULT

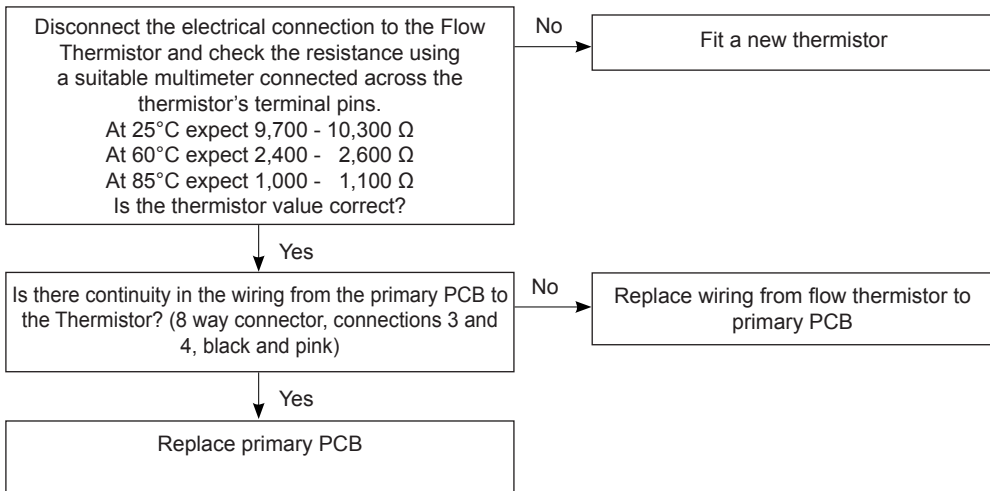

### 4.8 OUTSIDE SENSOR FAULT

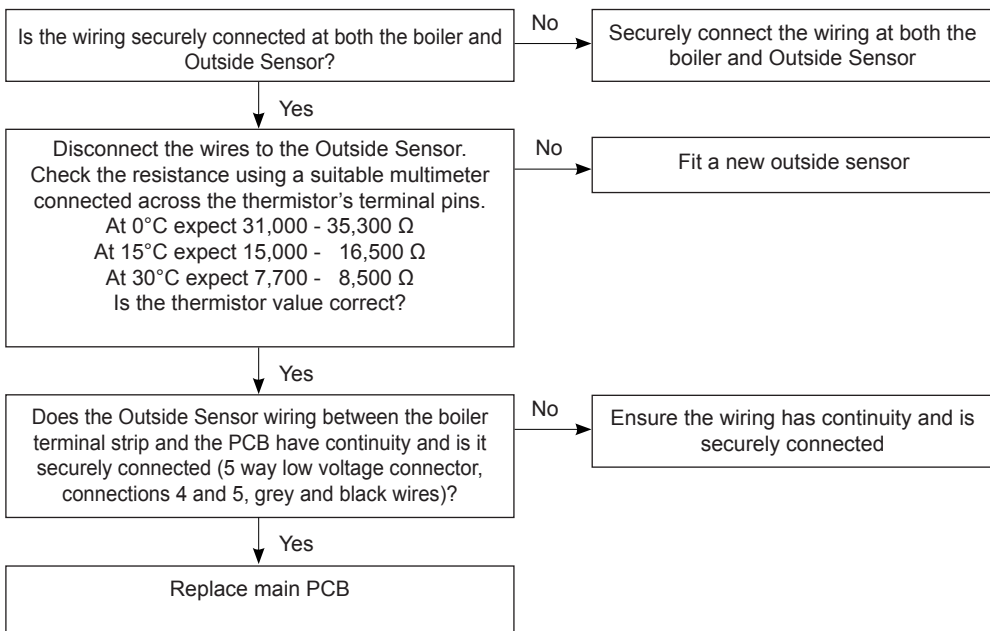

## SECTION 4 - FAULT FINDING

### 4.9 RETURN THERMISTOR FAULT

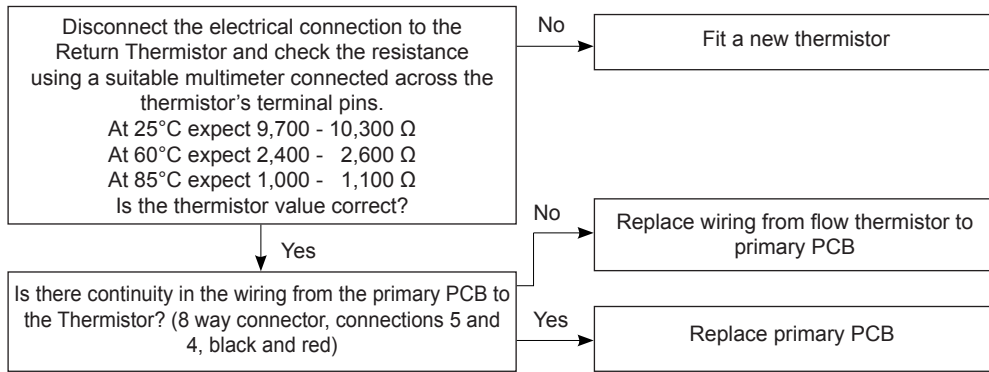

### 4.10 FAN FAULT

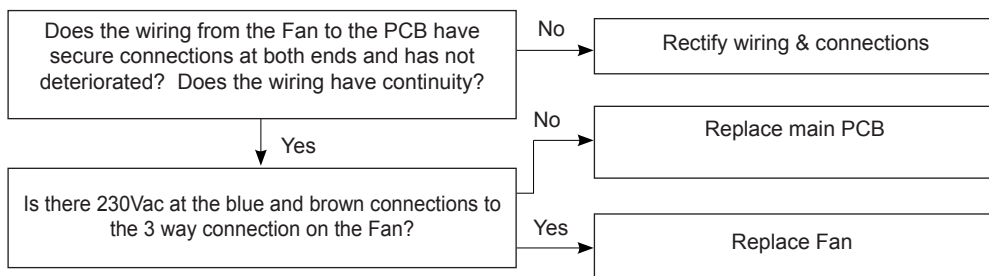

### 4.11 LOW WATER PRESSURE

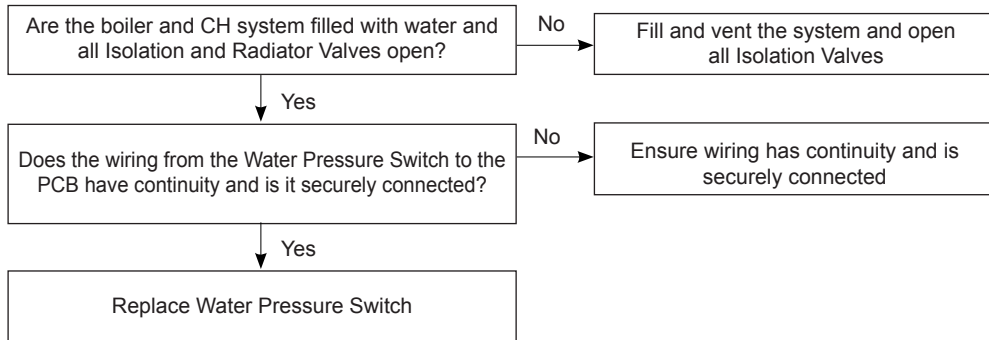

### 4.12 NO WATER FLOW

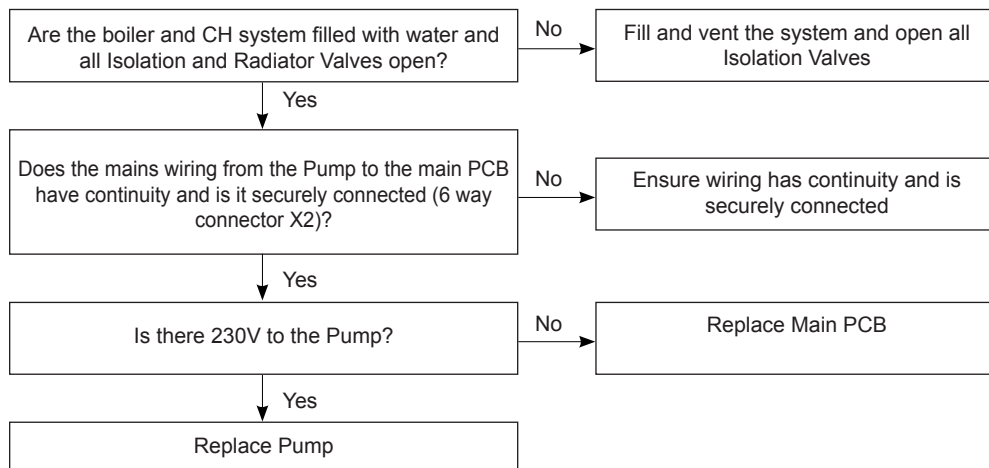

## SECTION 5 - SPARE PARTS

### 4.13 NO CONNECTION TO PRIMARY PCB

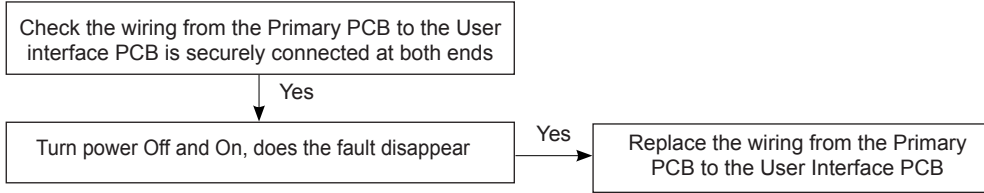

### 4.14 NO CH BUT DHW OK

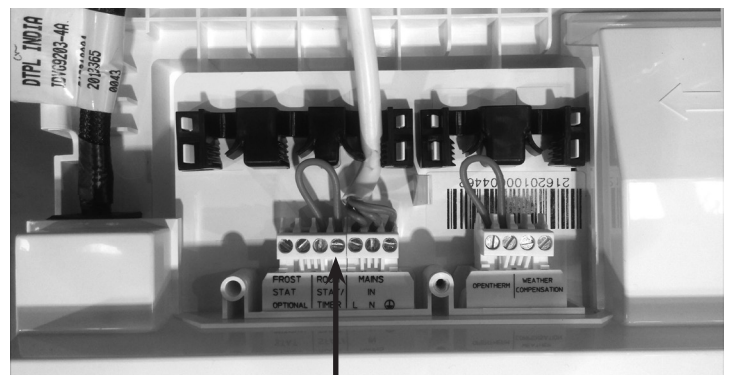
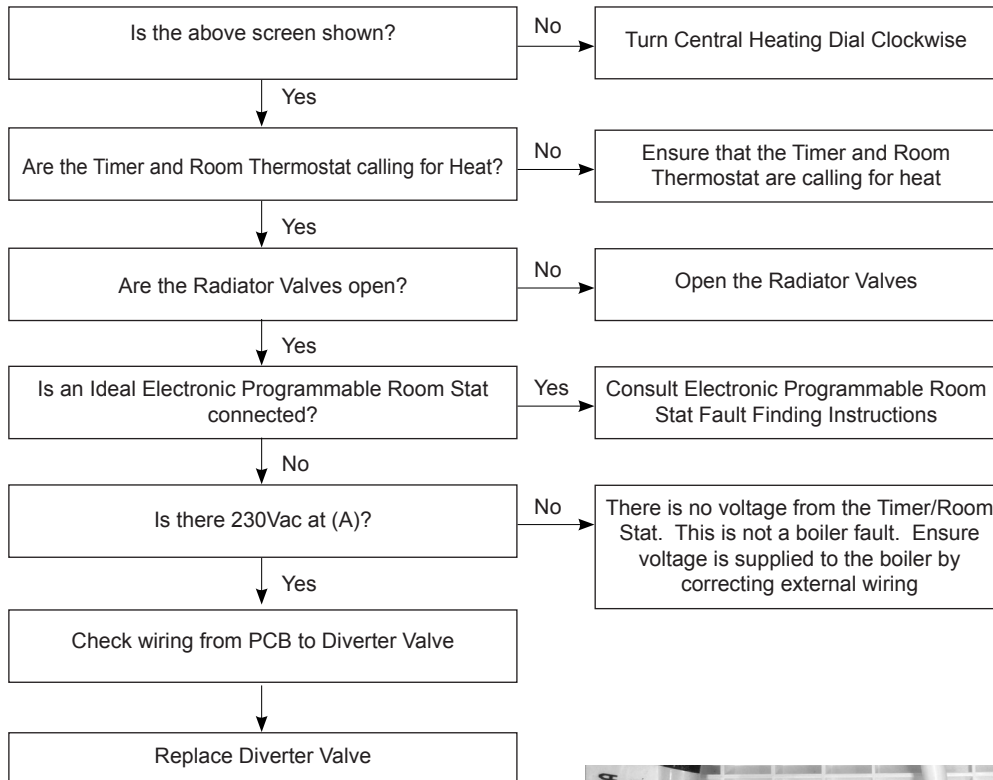
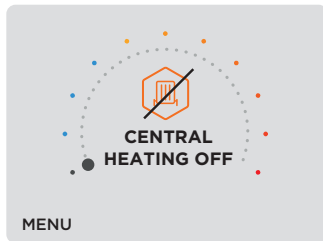

A



## SECTION 4 - FAULT FINDING

### 4.15 NO DHW BUT CH OK

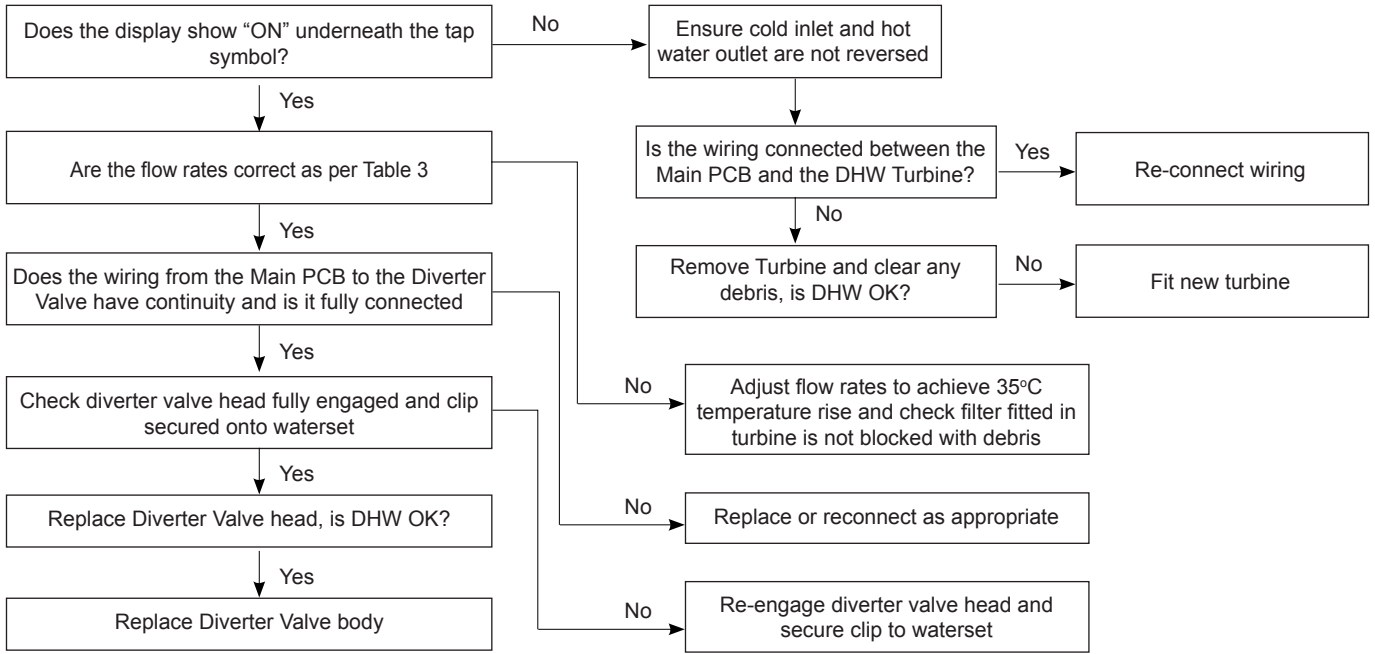

### 4.16 BLANK DISPLAY

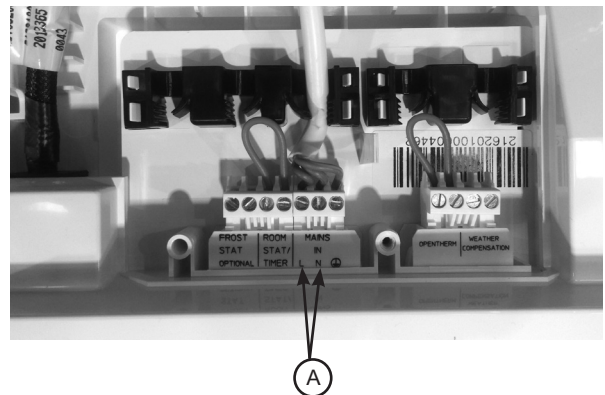
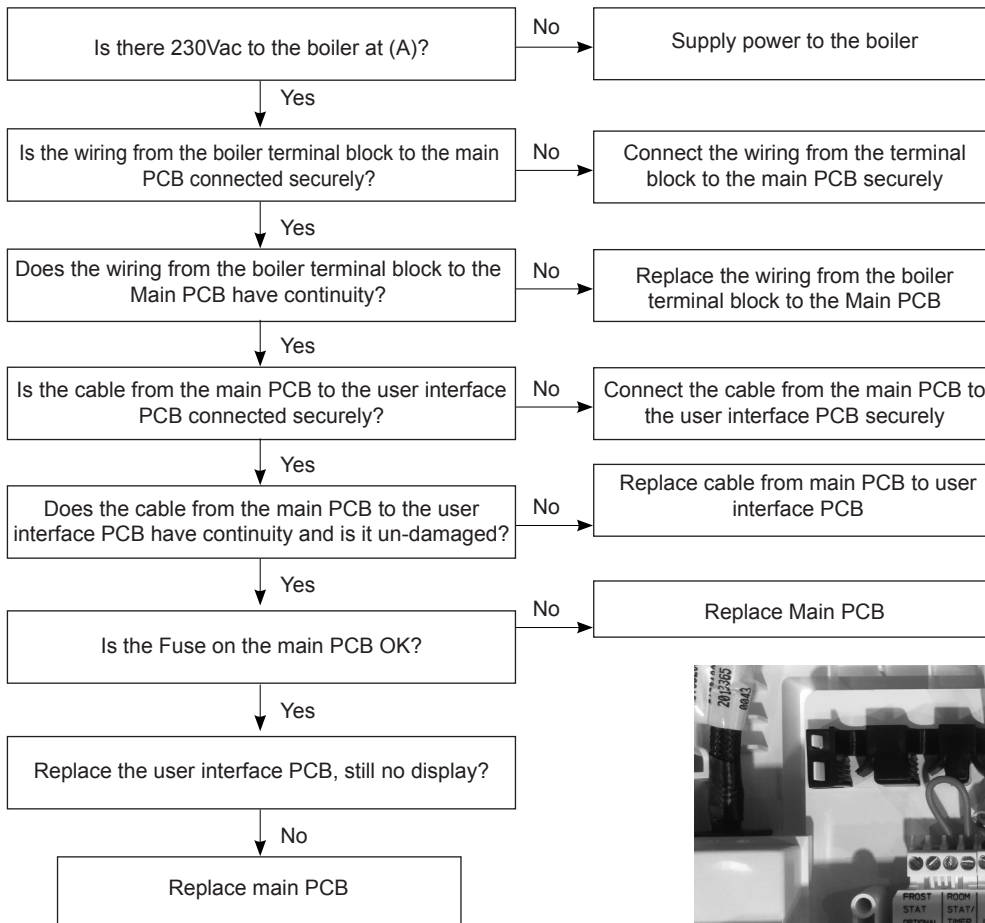

## SECTION 5 - SPARE PARTS

---

When replacing any part on this appliance use only spare parts that you can be assured conform to the safety and performance specification that we require. Do not use reconditioned or copy parts that have not been clearly authorised by Ideal. Failure to do so could affect safety or performance of this appliance.

Comprehensive spares parts information and details of approved Ideal Parts Distributors are available on [idealheating.com](http://idealheating.com)

**Our Parts team are also available to help with your Ideal Spare Parts enquiries on 01482 498665.**

When calling, and to ensure we can provide you with the most accurate parts information, please ensure you have the following to hand;

- Boiler Model
- Appliance GC Number
- Boiler Serial Number

### **IMPORTANT NOTE.**

**Propane Boilers** - After installation of a conversion kit, and when ordering future spares be sure to quote the serial letter code AAV - which indicates a Propane boiler - and the boilers original serial letter code from the original data plate.

# Code Of Practice

For the installation, commissioning and servicing of domestic heating and hot water products

Benchmark places responsibilities on both manufacturers and installers.\* The purpose is to ensure that customers\*\* are provided with the correct equipment for their needs, that it is installed, commissioned and serviced in accordance with the manufacturer's instructions by competent persons and that it meets the requirements of the appropriate Building Regulations. Installers are required to carry out work in accordance with the following:

## Standards of Work

- Be competent and qualified to undertake the work required.
- Install, commission, service and use products in accordance with the manufacturer's instructions provided.
- Ensure that where there is responsibility for design work, the installation is correctly sized and fit for purpose.
- Meet the requirements of the appropriate Building Regulations. Where this involves notifiable work be a member of a Competent Persons Scheme or confirm that the customer has notified Local Authority Building Control (LABC), prior to work commencing.
- Complete all relevant sections of the Benchmark Checklist/Service Record when carrying out commissioning or servicing of a product or system.
- Ensure that the product or system is left in a safe condition and, whenever possible, in good working order.
- Highlight to the customer any remedial or improvement work identified during the course of commissioning or servicing work.
- Refer to the manufacturer's helpline where assistance is needed.
- Report product faults and concerns to the manufacturer in a timely manner.

## Customer Service

- Show the customer any identity card that is relevant to the work being carried out prior to commencement or on request.
- Give a full and clear explanation/demonstration of the product or system and its operation to the customer.
- Hand over the manufacturer's instructions, including the Benchmark Checklist, to the customer on completion of an installation.
- Obtain the customer's signature, on the Benchmark Checklist, to confirm satisfactory demonstration and receipt of manufacturer's instructions.
- Advise the customer that regular product servicing is needed, in line with manufacturers' recommendations, to ensure that safety and efficiency is maintained.
- Respond promptly to calls from a customer following completion of work, providing advice and assistance by phone and, if necessary, visiting the customer.
- Rectify any installation problems at no cost to the customer during the installer's guarantee period.



\*The use of the word "installer" is not limited to installation itself and covers those carrying out installation, commissioning and/or servicing of heating and hot water products, or the use of supporting products (such as water treatment or test equipment).

\*\*Customer includes householders, landlords and tenants.

# Benchmark Commissioning & Warranty Validation Service Record

It is a requirement that the boiler is installed and commissioned to the manufacturers' instructions and the data fields on the commissioning checklist completed in full.

To instigate the boiler warranty the boiler needs to be registered with the manufacturer within one month of the installation. The warranty rests with the end-user (consumer), and they should be made aware it is ultimately their responsibility to register with the manufacturer, within the allotted time period.

It is essential that the boiler is serviced in line with the manufacturers' recommendations, at least annually. This must be carried out by a competent Gas Safe registered engineer. The service details should be recorded on the Benchmark Service and Interim Boiler Work Record and left with the householder. Failure to comply with the manufacturers' servicing instructions and requirements will invalidate the warranty.



[www.hhic.co.uk](http://www.hhic.co.uk)

**This Commissioning Checklist is to be completed in full by the competent person who commissioned the boiler as a means of demonstrating compliance with the appropriate Building Regulations and then handed to the customer to keep for future reference.**

Failure to install and commission according to the manufacturers' instructions and complete this Benchmark Commissioning Checklist will invalidate the warranty. This does not affect the customer's statutory rights.

\* All installations in England and Wales must be notified to Local Authority Building Control (LABC) either directly or through a Competent Persons Scheme. A Building Regulations Compliance Certificate will then be issued to the customer.

© Heating and Hotwater Industry Council (HHIC)



[www.centralheating.co.uk](http://www.centralheating.co.uk)

## GAS BOILER SYSTEM COMMISSIONING CHECKLIST & WARRANTY VALIDATION RECORD

Address:													
Boiler make and model:													
Boiler serial number:													
Commissioned by (PRINT NAME):						Gas Safe registration number:							
Company name:						Telephone number:							
Company email:						Company address:							
										Commissioning date:			
Heating and hot water system complies with the appropriate Building Regulations?											Yes		
Optional: Building Regulations Notification Number (if applicable):													
Time, temperature control and boiler interlock provided for central heating and hot water											Yes		
Boiler Plus requirements (tick the appropriate box(s))													
Boiler Plus option chosen for combination boiler in ENGLAND						Weather compensation			Smart thermostat with automisation and optimisation				
						Load compensation			Flue Gas Heat Recovery				
Time and temperature control to hot water			Cylinder thermostat and programmer/timer						Combination boiler				
Zone valves			pre-existing			Fitted			Not required				
Thermostatic radiator valves			pre-existing			Fitted			Not required				
Automatic bypass to system			pre-existing			Fitted			Not required				
Underfloor heating			pre-existing			Fitted			Not required				
Water quality													
The system has been flushed, cleaned and a suitable inhibitor applied upon final fill, in accordance with BS7593 and boiler manufacturers' instructions											Yes		
What system cleaner was used?						Brand:			Product:				
What inhibitor was used?						Brand:			Product:				
Primary water system filter			pre-existing			Fitted			Not required				
CENTRAL HEATING MODE measure and record (as appropriate)													
Gas rate (for combination boilers complete DHW mode gas rate)						m <sup>3</sup> /hr			or			ft <sup>3</sup> /hr	
Central heating output left at factory settings?											Yes	No	
If no, what is the maximum central heating output selected? <span style="float: right;">kW</span>													
Dynamic gas inlet pressure <span style="float: right;">mbar</span>													
Central heating flow temperature <span style="float: right;">°C</span>													
Central heating return temperature <span style="float: right;">°C</span>													
System correctly balanced/rebalanced?											Yes		
COMBINATION BOILERS ONLY													
Is the installation in a hard water area (above 200ppm)?						Yes			No				
Water scale reducer/softener			pre-existing			Fitted			Not required				
What type of scale reducer/softener has been fitted?						Brand:			Product:				
Water meter fitted?											Yes	No	
If yes- DHW expansion vessel			pre-existing			Fitted			Not required				
Pressure reducing valve			pre-existing			Fitted			Not required				
DOMESTIC HOT WATER MODE Measure and record													
Gas rate						m <sup>3</sup> /hr			or			ft <sup>3</sup> /hr	
Dynamic gas inlet pressure at maximum rate <span style="float: right;">mbar</span>													
Cold water inlet temperature <span style="float: right;">°C</span>													
Hot water has been checked at all outlets											Yes	Temperature	°C
CONDENSATE DISPOSAL													
The condensate drain has been installed in accordance with the manufacturers' instructions and/or BS5546/BS6798											Yes		
Point of termination						Internal			External (only where internal termination impractical)				
Method of disposal						Gravity			Pumped				
ALL INSTALLATIONS													
Record the following		At max rate:		CO ppm		CO <sub>2</sub> %		CO/CO <sub>2</sub>		Ratio			
		At min rate (where possible)		CO ppm		CO <sub>2</sub> %		CO/CO <sub>2</sub>		Ratio			
Where possible, has a flue integrity check been undertaken in accordance with manufacturers' instructions, and readings are correct?											Yes		
The operation of the boiler and system controls have been demonstrated to and understood by the customer											Yes		
The manufacturers' literature, including Benchmark Checklist and Service Record, has been explained and left with the customer											Yes		
Commissioning Engineer's signature													
Customer's signature (To confirm satisfactory demonstration and receipt of manufacturers' literature)													

\* All installations in England and Wales must be notified to Local Authority Building Control (LABC) either directly or through a Competent Persons Scheme. A Building Regulations Compliance Certificate will then be issued to the customer.

© Heating and Hotwater Industry Council (HHIC)



www.centralheating.co.uk

# SERVICE & INTERIM BOILER WORK RECORD

It is recommended that your boiler and heating system are regularly serviced and maintained, in line with manufacturers' instructions, and that the appropriate service / interim work record is completed.

## Service provider

When completing a service record (as below), please ensure you have carried out the service as described in the manufacturers' instructions. Always use the manufacturers' specified spare parts.

<b>SERVICE/INTERIM WORK ON BOILER</b> <small>delete as appropriate</small>					Date:	
Engineer name:		Company name:				
Telephone N°:		Gas Safe registration N°:				
Max rate	CO	ppm	CO <sub>2</sub>	%	CO/CO <sub>2</sub>	
Min rate	CO	ppm	CO <sub>2</sub>	%	CO/CO <sub>2</sub>	
Where possible, has a flue integrity check been undertaken in accordance with manufacturers' instructions, and readings are correct?*					yes	
Gas rate:	m <sup>3</sup> /h	OR	ft <sup>3</sup> /h			
Were parts fitted? <small>delete as appropriate</small>		Yes	No			
Parts fitted:						
System inhibitor concentration has been checked and appropriate action taken, in accordance with BS 7593 and boiler manufacturers' instructions. *					yes	n/a
Comments:						
Signature:						

<b>SERVICE/INTERIM WORK ON BOILER</b> <small>delete as appropriate</small>					Date:	
Engineer name:		Company name:				
Telephone N°:		Gas Safe registration N°:				
Max rate	CO	ppm	CO <sub>2</sub>	%	CO/CO <sub>2</sub>	
Min rate	CO	ppm	CO <sub>2</sub>	%	CO/CO <sub>2</sub>	
Where possible, has a flue integrity check been undertaken in accordance with manufacturers' instructions, and readings are correct?*					yes	
Gas rate:	m <sup>3</sup> /h	OR	ft <sup>3</sup> /h			
Were parts fitted? <small>delete as appropriate</small>		Yes	No			
Parts fitted:						
System inhibitor concentration has been checked and appropriate action taken, in accordance with BS 7593 and boiler manufacturers' instructions. *					yes	n/a
Comments:						
Signature:						

\*A System inhibitor efficacy test is required on every annual service in accordance with the manufacturers' instructions and BS 7593. It is only acceptable to not have undertaken this if the service engineers attendance visit was in between annual services to attend a non-water facing component.

\*A System inhibitor efficacy test is required on every annual service in accordance with the manufacturers' instructions and BS 7593. It is only acceptable to not have undertaken this if the service engineers attendance visit was in between annual services to attend a non-water facing component.

<b>SERVICE/INTERIM WORK ON BOILER</b> <small>delete as appropriate</small>					Date:	
Engineer name:		Company name:				
Telephone N°:		Gas Safe registration N°:				
Max rate	CO	ppm	CO <sub>2</sub>	%	CO/CO <sub>2</sub>	
Min rate	CO	ppm	CO <sub>2</sub>	%	CO/CO <sub>2</sub>	
Where possible, has a flue integrity check been undertaken in accordance with manufacturers' instructions, and readings are correct?*					yes	
Gas rate:	m <sup>3</sup> /h	OR	ft <sup>3</sup> /h			
Were parts fitted? <small>delete as appropriate</small>		Yes	No			
Parts fitted:						
System inhibitor concentration has been checked and appropriate action taken, in accordance with BS 7593 and boiler manufacturers' instructions. *					yes	n/a
Comments:						
Signature:						

<b>SERVICE/INTERIM WORK ON BOILER</b> <small>delete as appropriate</small>					Date:	
Engineer name:		Company name:				
Telephone N°:		Gas Safe registration N°:				
Max rate	CO	ppm	CO <sub>2</sub>	%	CO/CO <sub>2</sub>	
Min rate	CO	ppm	CO <sub>2</sub>	%	CO/CO <sub>2</sub>	
Where possible, has a flue integrity check been undertaken in accordance with manufacturers' instructions, and readings are correct?*					yes	
Gas rate:	m <sup>3</sup> /h	OR	ft <sup>3</sup> /h			
Were parts fitted? <small>delete as appropriate</small>		Yes	No			
Parts fitted:						
System inhibitor concentration has been checked and appropriate action taken, in accordance with BS 7593 and boiler manufacturers' instructions. *					yes	n/a
Comments:						
Signature:						

\*A System inhibitor efficacy test is required on every annual service in accordance with the manufacturers' instructions and BS 7593. It is only acceptable to not have undertaken this if the service engineers attendance visit was in between annual services to attend a non-water facing component.

\*A System inhibitor efficacy test is required on every annual service in accordance with the manufacturers' instructions and BS 7593. It is only acceptable to not have undertaken this if the service engineers attendance visit was in between annual services to attend a non-water facing component.

<b>SERVICE/INTERIM WORK ON BOILER</b> <small>delete as appropriate</small>					Date:	
Engineer name:		Company name:				
Telephone N°:		Gas Safe registration N°:				
Max rate	CO	ppm	CO <sub>2</sub>	%	CO/CO <sub>2</sub>	
Min rate	CO	ppm	CO <sub>2</sub>	%	CO/CO <sub>2</sub>	
Where possible, has a flue integrity check been undertaken in accordance with manufacturers' instructions, and readings are correct?*					yes	
Gas rate:	m <sup>3</sup> /h	OR	ft <sup>3</sup> /h			
Were parts fitted? <small>delete as appropriate</small>		Yes	No			
Parts fitted:						
System inhibitor concentration has been checked and appropriate action taken, in accordance with BS 7593 and boiler manufacturers' instructions. *					yes	n/a
Comments:						
Signature:						

<b>SERVICE/INTERIM WORK ON BOILER</b> <small>delete as appropriate</small>					Date:	
Engineer name:		Company name:				
Telephone N°:		Gas Safe registration N°:				
Max rate	CO	ppm	CO <sub>2</sub>	%	CO/CO <sub>2</sub>	
Min rate	CO	ppm	CO <sub>2</sub>	%	CO/CO <sub>2</sub>	
Where possible, has a flue integrity check been undertaken in accordance with manufacturers' instructions, and readings are correct?*					yes	
Gas rate:	m <sup>3</sup> /h	OR	ft <sup>3</sup> /h			
Were parts fitted? <small>delete as appropriate</small>		Yes	No			
Parts fitted:						
System inhibitor concentration has been checked and appropriate action taken, in accordance with BS 7593 and boiler manufacturers' instructions. *					yes	n/a
Comments:						
Signature:						

\*A System inhibitor efficacy test is required on every annual service in accordance with the manufacturers' instructions and BS 7593. It is only acceptable to not have undertaken this if the service engineers attendance visit was in between annual services to attend a non-water facing component.

\*A System inhibitor efficacy test is required on every annual service in accordance with the manufacturers' instructions and BS 7593. It is only acceptable to not have undertaken this if the service engineers attendance visit was in between annual services to attend a non-water facing component.

\* All installations in England and Wales must be notified to Local Authority Building Control (LABC) either directly or through a Competent Persons Scheme. A Building Regulations Compliance Certificate will then be issued to the customer.



# FLOWCHART FOR CO LEVEL AND COMBUSTION RATIO CHECK ON COMMISSIONING A CONDENSING BOILER

## Important Preliminary Information on Checks

The air gas ratio valve is factory-set and must not be adjusted DURING COMMISSIONING.

If the boiler requires conversion to operate with a different gas family (e.g. conversion from natural gas to LPG) separate guidance is provided with the conversion kit supplied and this must be followed.

### PRIOR TO CO LEVEL AND COMBUSTION RATIO CHECK

The installation instructions must have been followed, gas type verified and gas supply pressure / gas rate checked as required prior to commissioning.

As part of the installation process, ESPECIALLY WHERE A FLUE HAS BEEN FITTED BY PERSONS OTHER THAN THE BOILER INSTALLER, visually check the integrity of the whole flue system to confirm that all components are correctly assembled, fixed and supported. Check that maximum flue lengths have not been exceeded and all guidance has been followed (e.g. Gas Safe Register Technical Bulletin (TB) 008 where chimney/flues are in voids).

The ECGA should be of the correct type, as specified by BS 7967.

Prior to its use, the ECGA should have been maintained and calibrated as specified by the manufacturer. The installer must have the relevant competence for use of the analyser.

Check and zero the analyser IN FRESH AIR in accordance with the analyser manufacturer's instructions.

#### KEY:

**CO** = carbon monoxide

**CO<sub>2</sub>** = carbon dioxide

**O<sub>2</sub>** = oxygen

**Combustion Ratio** = The CO reading measured in ppm divided by the CO<sub>2</sub> reading first converted to ppm

**ppm** = parts per million

**GS(I&U)R** = Gas Safety (Installation and Use) Regulations

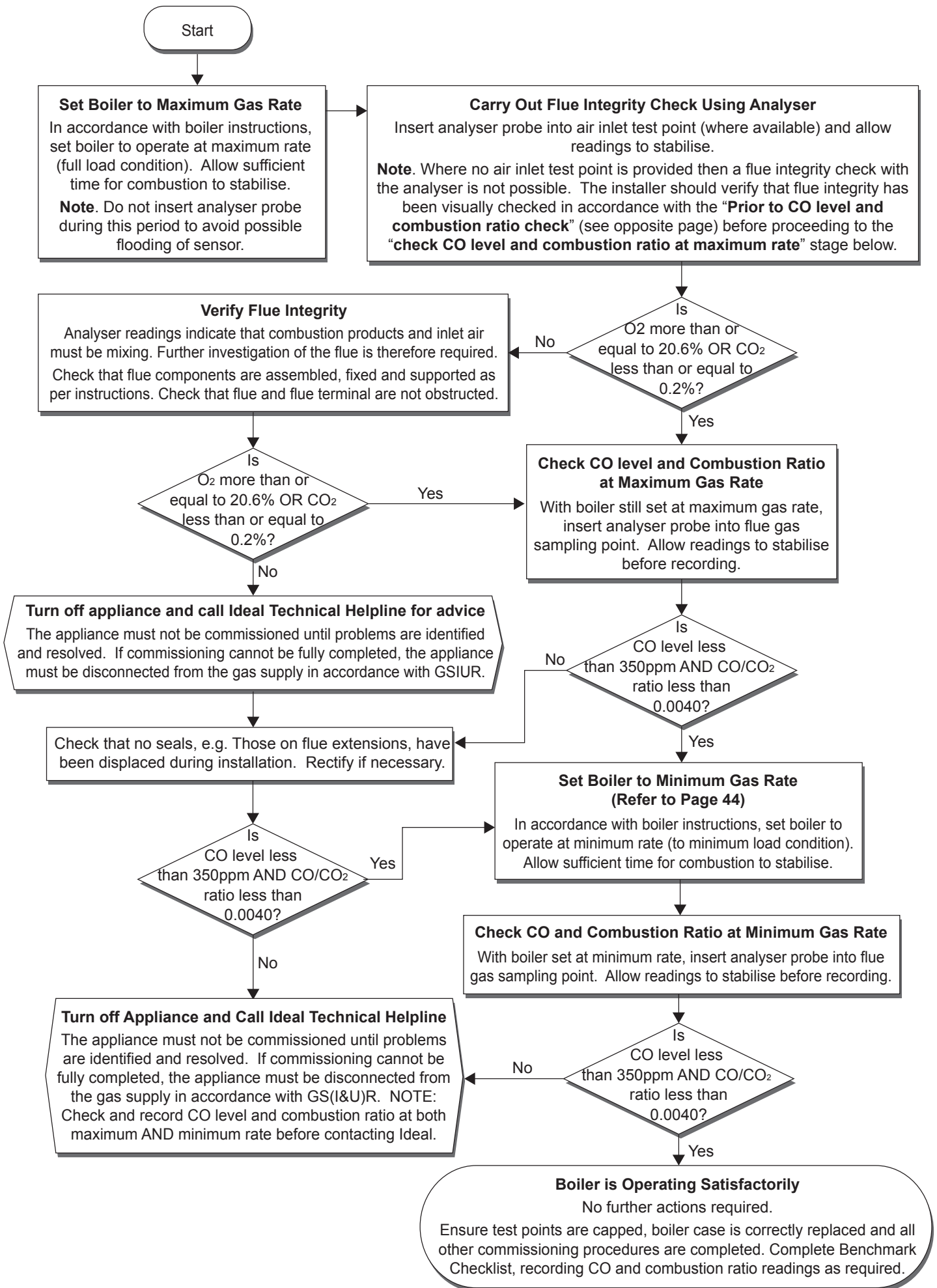



## NOTES

## NOTES

## NOTES



**WEEE DIRECTIVE 2012/19/EU  
Waste Electrical and Electronic Equipment Directive**

- At the end of the product life, dispose of the packaging and product in a corresponding recycle centre.
- Do not dispose of the unit with the usual domestic refuse.
- Do not burn the product.
- Remove the batteries.
- Dispose of the batteries according to the local statutory requirements and not with the usual domestic refuse.



The code of practice for the installation, commissioning & servicing of central heating systems

At Ideal Heating we take our environmental impact seriously, therefore when installing any Ideal Heating product please make sure to dispose of any previous appliance in an environmentally conscious manner. Households can contact their local authority to find out how. See <https://www.gov.uk/managing-your-waste-an-overview> for guidance on how to efficiently recycle your business waste.

### Technical Training

Our Expert Academy offer a range of training options designed and delivered by our experts in heating. For details please contact: [expert-academy.co.uk](http://expert-academy.co.uk)

Ideal Boilers Ltd., pursues a policy of continuing improvement in the design and performance of its products. The right is therefore reserved to vary specification without notice.

Ideal is a trademark of Ideal Heating.

Registered Office

Ideal Boilers Ltd., National Avenue, Hull, East Yorkshire, HU5 4JB

Tel 01482 492251 Fax 01482 448858

Registration No. London 322 137

EU Authorised Representative:

Atlantic SFDT

44 Boulevard des Etats-Unis, 85 000 La Roche-Sur-Yon, France

+33 (0)2 51 44 34 34

Ideal Technical Helpline: 01482 498663

Ideal Consumer Helpline: 01482 498660

Ideal Parts: 01482 498665

[idealheating.com](http://idealheating.com)

**ideal**  
HEATING