



EXPERTS IN HEATING FOR OVER 100 YEARS



Rated 'Excellent' on  Trustpilot with over 43,000 reviews.*

With a legacy that spans over five decades, Groupe Atlantic have emerged as a leading European player, setting the standards for sustainable heating and hot water solutions.

/ EXPERTISE THAT KNOWS NO BOUNDARIES

Groupe Atlantic boasts a multi-energy expertise that encompasses electric, gas and renewables. This unparalleled knowledge underpins the comprehensive range of heating and hot water solutions, catering to the diverse needs of domestic and commercial sectors. Groupe Atlantic is not just attentive of its markets, it shapes them. The brands that are part of the group, Ideal Heating, Atlantic and Gledhill offer a wide spectrum of products, from water heaters and electric heaters to domestic and commercial boilers and heat pumps.

/ A RICH HISTORY OF INNOVATION

Founded in 1968 in La Roche-sur-Yon, France, Groupe Atlantic has been at the forefront of revolutionising comfort and sustainability. Commitment to excellence has led to the establishment of 31 industrial sites and 43 commercial manufacturing sites, ensuring a presence and impact on a global scale.

/ A GLOBAL PRESENCE

Spanning five continents, Groupe Atlantic is not just a company; it's a worldwide community dedicated to enhancing heating and hot water.

Inside these pages, you'll discover how the Groupe Atlantic's brands Ideal Heating, Atlantic, and Gledhill stand as beacons of innovation, and how its commitment to sustainability drives every aspect of its work.



EXPERTS IN HEATING

At Ideal Heating, we are experts in domestic heating and hot water solutions.

The last thing you should worry about is your boiler, therefore we rigorously test each and every one of our products with dozens of safety and reliability checks before they leave our Yorkshire based factory. This is why we confidently offer industry leading warranties on our boilers so we can go the extra mile for our customers.

Should you need us, our UK based contact centre is open 364 days a year. If your query isn't resolved over the phone, we aim to get an engineer to your property the same day or the next.

BOILERS 4

Which type of boiler is ideal for your home? 6

Logic MAX 8

Vogue MAX 10

Vogue 12

Logic+ 13

Sort contents
when done

Logical Solutions 20

Logic Air Heat Pump 22

Logic Air Pre-Plumbed Cylinders 30

Halo Air 34

Logic Air Control Box 36

Industry leading customer service 37

WHICH TYPE OF BOILER IS IDEAL FOR YOUR HOME?

COMBI BOILER ONLY



Our combi range includes our award winning Logic MAX Combi and the unrivalled premium Vogue MAX Combi boiler. Both models come in a range of outputs meaning they can heat homes of various sizes.

A combi boiler is perfect for a small to medium sized property, providing mains pressure hot water on demand with no need for a hot water cylinder or feed/expansion tank. They are the full package in one compact unit supplying heat to your radiator system, and hot water.

Combi boilers are extremely efficient as they only heat water when it is needed, reducing bills and your household's carbon footprint.

SYSTEM BOILER + CYLINDER



The Vogue MAX and Logic MAX models are available in the Ideal system range. Both are perfect for homes with multiple bathrooms.

System boilers are suited to homes with multiple bathrooms and can provide a constant supply of hot water to numerous taps at once.

System boilers require a cylinder to store hot water, however, they don't require a feed/expansion tank, so they are ideal for larger properties with little or no loft space.

HEAT ONLY BOILER + CYLINDER + WATER FEED TANKS



The Logic MAX Heat comes with a 10 year parts and labour warranty and is compatible with a range of cylinders. Perfect for the replacement of most traditional boilers.

Heat only boilers are perfect for homes with multiple bathrooms, or where there is a large demand for hot water at once.

They are often thought of as a traditional boiler. They work alongside a separate hot water cylinder which is usually found in an airing cupboard, and a feed/expansion tank often found in the loft, so they are ideal for homes that already have a heat only boiler.

LOGIC MAX

COMBI 24 30 35 kW

SYSTEM 15 18 24 30 kW

HEAT 12 15 18 24 30 kW



Scan me for full technical specification

With over four million Logic boilers sold in the UK, it has the reputation as one of the most reliable boilers available. We back this up with our 10 year warranty as standard for the Logic MAX.

10 YEAR WARRANTY*

KEY FEATURES

- ✓ Which? User recommended
- ✓ Reduced running costs due to class leading efficiency
- ✓ Peace of mind with support 364 days a year
- ✓ Faster hot water with intelligent pre-heat
- ✓ Large colour screen and simple user interface
- ✓ Compatible with our Halo controls for increased efficiency and comfort
- ✓ Helpful reminder service indication
- ✓ Easier re-pressurisation with coloured valve handles
- ✓ Built-in frost protection



COMPATIBLE WITH HALO

OVER A DECADE OF INNOVATION

For over a decade our Logic range has been heating homes all over the UK. In April 2022 we built our four millionth Logic boiler meaning we will be providing reliable warmth to millions of people for years to come.

First launched in 2009 the Logic range represents over 100 years of our advancement in heating technology. Our time served experience and products can give you peace in mind.

WE BELIEVE IN A QUIET HOME

The Logic MAX range* has been awarded the Quiet Mark, and is one of only a very small number of boiler ranges to have achieved this.

Our boilers have also been awarded Good Housekeeping Reader Recommended status eight years in a row. For outstanding product features that left customers wanting to recommend Ideal Heating to their friends and families.



PROTECTING YOUR HEATING SYSTEM

The Logic MAX comes with an Ideal System Filter in the box. Our system filter has been proven to ensure long lasting protection of the boiler and heating system with no compromise on performance.



*The Quiet Mark has been awarded to Logic MAX Combi (30/35kW), Heat (12kW) and System (15/18kW).



*Subject to terms and conditions. 10 year parts and labour warranty as standard when registered within 30 days of installation.

VOGUE MAX

COMBI 26 32 40 kW

SYSTEM 15 18 26 32 kW



Scan me for full technical specification

Over a century of heating innovation has led to one thing: the Vogue MAX.

A combination of sleek aesthetics and best in class components means the Vogue MAX sits at the pinnacle of the Ideal range with an impressive 12 year warranty.

12 YEAR WARRANTY*

KEY FEATURES

- ✓ Which? User recommended
- ✓ Peace of mind with support 364 days a year
- ✓ Stylish aesthetics with full width door complete with damped opening
- ✓ Compatible with our Halo controls for increased efficiency and comfort
- ✓ Backlit 3.5" LCD full colour screen
- ✓ Multi-function buttons for simplified end user operation
- ✓ Helpful reminder service indication



COLOUR

EASY TO USE
FULL COLOUR
DISPLAY

BRITISH MADE SINCE 1906

First created at our factory in Yorkshire, the Vogue MAX has been designed, developed and built in the UK. Each year we invest into our UK based research and development facility ensuring our boilers are at the cutting edge of heating technology.



AWARD WINNING BOILERS

Our boilers have been awarded Good Housekeeping Reader Recommended status for eight consecutive years, for ease of use and low noise levels amongst other outstanding product details that left customers wanting to recommend Ideal Heating to their friends and families.

PROTECTING YOUR HEATING SYSTEM

The Vogue MAX comes with an Ideal System Filter in the box. Our system filter has been proven to ensure long lasting protection of the boiler and heating system with no compromise on performance.



PEACE OF MIND
WITH SUPPORT **364**
DAYS A YEAR



*Subject to terms and conditions. 12 year parts and labour warranty available to Max Accredited Installers. 10 year parts and labour warranty as standard when registered within 30 days of installation.

VOGUE

COMBI 26 32 40 kW

SYSTEM 15 18 26 32 kW



Scan me for full technical specification

BEST IN CLASS

The Vogue provides stylish aesthetics and premium components combined with an 8 year warranty.

With an easy to use colour screen, high outputs of up to 40kW (combi) and a quality stainless steel heat exchanger it is truly a premium boiler.

8 YEAR WARRANTY*

KEY FEATURES

- ✓ Which? User recommended
- ✓ Compatible with our Halo controls for increased efficiency and comfort
- ✓ Helpful reminder service indication



A

EFFICIENCY RATING

*Subject to terms and conditions. 8 year parts and labour warranty as standard when registered within 30 days of installation.

LOGIC+

COMBI 24 30 35 kW

SYSTEM 15 18 24 30 kW

HEAT 12 15 18 24 30 kW



Scan me for full technical specification

The Logic+ has received Good Housekeeping Reader Recommendation for eight years in a row.

7 YEAR WARRANTY*

KEY FEATURES

- ✓ Reduced running costs due to class leading efficiency
- ✓ Compact cupboard fit
- ✓ Low lift weight
- ✓ Large output range
- ✓ Halo compatible
- ✓ Large colour screen and simple user interface
- ✓ Compression fitting included with Combi and System models

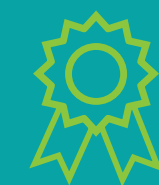

AWARD WINNING BOILER

*Subject to terms and conditions. 7 year parts and labour warranty as standard when registered within 30 days of installation.

HALO WI-FI

PROGRAMMABLE ROOM THERMOSTATS BOILERS ONLY



Scan me for full technical specification

HALO WI-FI

222143

Halo Wi-Fi comes with the same benefits as the Halo RF, but with app-controlled heating, which gives you full control of your heating through your phone or device. Halo is also compatible with Amazon Alexa and Google Home, allowing you to control your heating and find out the temperature, all with your voice.

Halo Wi-Fi comes in a Combi and Heat & System range.



GEO-LOCATION FOR LIFESTYLE BASED HEATING

KEY FEATURES

- ✓ Compatible with Ideal Boilers
- ✓ Easy app set-up
- ✓ Smart home compatible
- ✓ Control your heating anywhere via the app
- ✓ Smart support from Ideal customer service

2 YEAR WARRANTY*

*Two year parts and labour warranty available when registered within 30 days of installation. Terms and conditions apply.



HALO

PROGRAMMABLE ROOM THERMOSTATS BOILERS ONLY



Scan me for full technical specification

HALO RF 222141

Halo RF is a wireless programmable room thermostat, designed to work specifically with your Ideal Heating boiler. Halo RF offers you fast, flexible and intelligent wireless technology and is packed with a wide range of features that enable simple and easy heating control, this includes flexible scheduling, override, plus hours, fault notifications, holiday mode and child lock.

Halo's compact and contemporary design makes it suitable for any home, either modestly mounted to the wall or discretely desktop mounted using the stand.

Halo RF comes in a Combi and Heat & System range.



SIMPLE DIAL AND BUTTON INTERFACE THAT'S EASY FOR EVERYONE TO USE

KEY FEATURES

- ✓ Compatible with Ideal Boilers
- ✓ Easily adjustable schedule to fit with your lifestyle
- ✓ Large, clear, colour screen

2 YEAR WARRANTY*

*Two year parts and labour warranty available when registered within 30 days of installation. Terms and conditions apply.

HALO LITE RF 237423

The Ideal Halo Lite RF is a single zone combi programmable room thermostat designed to benefit both installers and homeowners.

Boasting a large colour screen and easy to use button and dial interface. It has been tested to ensure it is intuitive and easy to understand.



2 YEAR WARRANTY*

HALO 2-ZONE EXTENSION KIT 222145

Enjoy the benefits of a multi-zone heating with the Halo 2-Zone Extension kit.

The Halo 2-Zone Extension kit is available for both Halo RF and Halo Wi-Fi, offering an extra level of heating control. Split your home into two separate zones of heating, setting a separate heating schedule and temperature range for the second zone. So if you're spending your days downstairs, you can set your upstairs heating to come on later helping to save energy.

The Halo 2-Zone Extension kit is fully modulating on both heating zones, helping to save energy usage.



TAILORED HEATING OVER 2 ZONES

*Two year parts and labour warranty available when registered within 30 days of installation. Terms and conditions apply.

ENERGY EFFICIENCY

WHAT IS ERP?

- > ErP is a regulation put in place by the European Union to increase the visibility of the efficiency and performance of heating and hot water products, allowing you to be aware of the impact of your purchases.
- > Efficiency isn't something you need to worry about when choosing Ideal Heating, as all of our boilers achieve band A levels of efficiency, helping you to reduce your energy bills and carbon footprint.

ALL OF OUR BOILERS
ACHIEVE BAND A ERP
RATING OF AT LEAST

92%

WHAT IS BOILER PLUS?

- > Boiler Plus is a Government regulation that was implemented in 2018, to improve energy efficiency in homes in England.
- > Boiler Plus regulations only apply to replacement boilers being installed, so you don't need to worry about bringing your existing boiler up to standards.
- > If you're fitting a replacement boiler the good news is that Ideal Heating has everything you need to comply, with all of our boilers achieving at least 92% ErP rating as standard, and a whole range of controls to suit your customers' needs!

DECARBONISATION

Decarbonisation and the drive towards Net Zero by 2050 is fast becoming a reality, with the UK government committing to a national target of Net Zero carbon emissions by 2050. This means the way we provide heating and hot water to homes will fundamentally change over the coming years.

The Logic Air heat pump takes all the experience we have across the globe and throughout Europe to deliver heat pump technology that works and provides optimum comfort and efficiency. The Ideal heat pump package combines three revolutionary products:

- > **Our quiet, compact and highly efficient monobloc heat pump**
- > **Our industry leading pre-plumbed heat pump cylinder**
- > **The Halo Air heat pump thermostat**

Designed to operate seamlessly, our industry leading heat pump, highly efficient hot water cylinder and Halo room thermostat provide all the components for a reliable and efficient heat pump system. Supported by national customer service and engineer support. The Logic Air range offers the complete low carbon package.

“We have the knowledge, experience and skills to play our part in ensuring the nation achieves its **Net Zero** targets and so our customers have the best and most advanced solutions for heating and hot water, whatever their needs and requirements.”



SHAUN EDWARDS
CEO

LOGICAL SOLUTIONS



EFFICIENCY

The efficiency rating of a heat pump determines how much it costs to use. A high efficiency rating means it costs less to operate. Ideal heat pumps have one of the highest efficiency ratings in the UK, rated up to 5.19 (Coefficient of performance) making them one of the most economical heat pumps on the market.



SOUND AND DIMENSIONS

Sound and dimensions are important, not just for our customers comfort level, but to MCS and the Planning office. Our heat pumps are quiet and compact. Small enough for permitted development with the local planning authority and cutting edge acoustic technology makes its low sound levels amongst the best in the market.



FAST HEAT PUMP INSTALLATION

Our heat pumps, pre-plumbed cylinders and Halo Air room thermostat are designed to be amongst the fastest heat pumps to install. Factory fitted components, click and connect wiring terminals reduce installation time and improve installation reliability.



HOT WATER

Ensuring enough hot water can be generated efficiently and quickly is crucial to a heat pump system. Our range of pre-plumbed hot water cylinders can generate hot water faster than some of the most popular heat pump DHW cylinders in the UK, saving money and energy.



SIMPLE TO USE, APP CONTROL AND ONLINE HEALTH CHECKS

Halo Air is a new generation of heat pump thermostats connected to your phone with options to connect to our customer service team. Halo Air automatically makes your heating system more efficient, enables remote control and 24/7 system performance data. All wrapped up in an easy to use controller.



SUPPORT

Our heat pumps, pre-plumbed cylinders and heat pump thermostats are backed by our warranty which covers all parts and labour as well as our award winning technical and customer support offering over the phone, video call and in-person support 364 days a year.



LOGIC AIR

HEAT PUMP 4 5 8 10 kW



Scan me for full technical specification

The Logic Air monobloc heat pump, offers great efficiencies both in heating and hot water. The Logic Air is designed to deliver efficient, simple and reliable low carbon heating in homes throughout the UK.



KEY FEATURES

- ✓ Designed for the UK climate
- ✓ Quiet operation
- ✓ Hot water in rain, ice and snow
- ✓ Flexible warranty
- ✓ 364 day a year UK customer service
- ✓ SCOP rating up to 519%*

A+++ EFFICIENCY RATING

OVERVIEW

Taking the learnings from the award winning Logic boiler, the Logic Air heat pump integrates seamlessly with UK homes, partnered with our best in class pre-plumbed hot water cylinder and our connected Halo Air room thermostat, the Logic Air is quick to install, easy to commission and simple to use.

Our new heat pumps are supported by our industry leading customer service and warranty team which is based in the UK and is open 364 days a year, providing customer service and technical support.

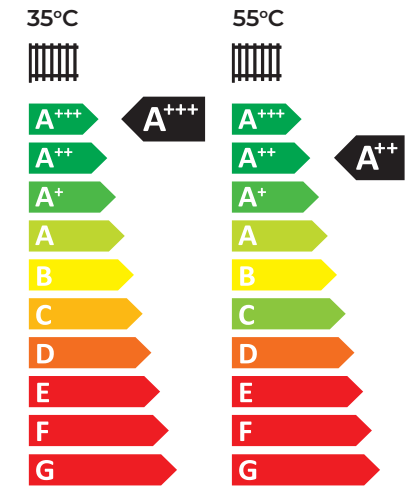

DIMENSIONS

All Dimensions in mm

	4kW & 5kW	8kW & 10kW
A	798	1008
B	518	518
C	1095	1095
D	499	499
E	518	518
F	558	558
G	688	688
H	516	516
I	80	80
J	184	184
K	140	140
L	95	95
M	84	84
N	48	48
O	90	90
P	103	105

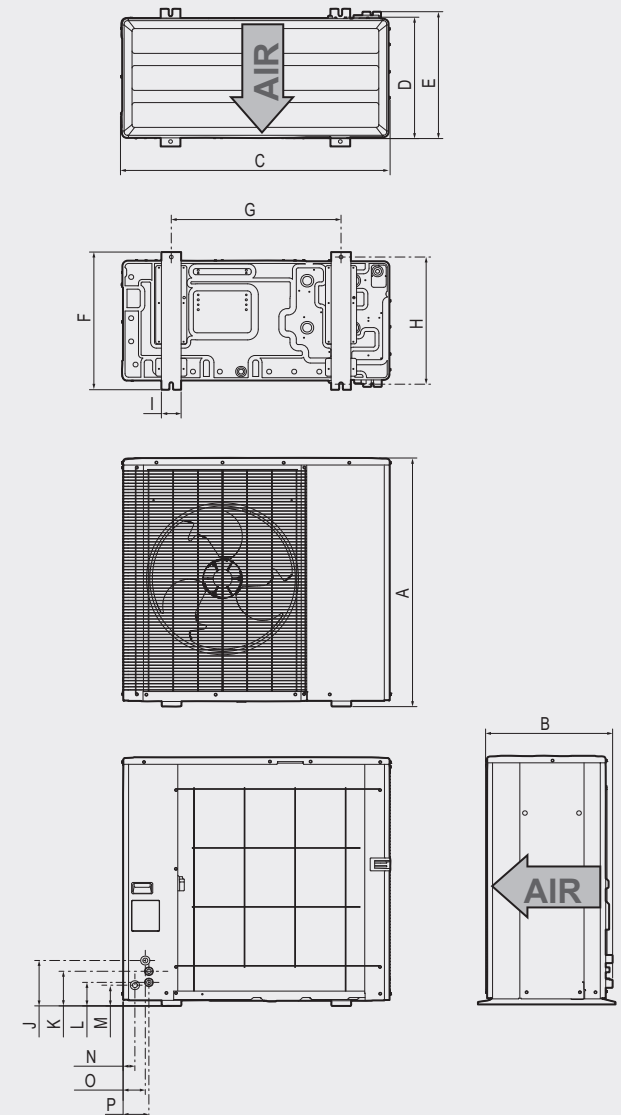

*Performance data in accordance with EN 14825, EN 12102-1, EN 14511. The energy efficiency provided may not correspond to the actual energy once installed in a building, as the efficiency is influenced by other factors such as heat loss in the distribution system and the capacity of the products in relation to building size and characteristics.

HP290 MONOBLOC

HEAT PUMP 4.5 6 8 10 12 14 kW



Scan me for full technical specification

The HP290 monobloc heat pump offers a low-GWP refrigerant with high efficiencies.

KEY FEATURES

- ✓ Low GWP R290 refrigerant
- ✓ Highly efficient: SCOP up to 500%*
- ✓ Intuitive control: smart weather compensating controls
- ✓ Low carbon refrigerant: zero ozone depletion and low global warming potential
- ✓ Smart grid and solar PV compatible
- ✓ Monobloc technology enables easy installation and servicing
- ✓ Domestic hot water: hot, efficient and fast reheat times with the ideal heat pump cylinder range
- ✓ Flow temperatures up to 75°C



A+++ EFFICIENCY RATING

OVERVIEW

The HP290 can provide efficient heating and hot water throughout the year by utilising our pre-plumbed and pre-wired cylinder. The system offers our users an aesthetically pleasing heating solution and when paired with Halo Lite RF, a great user experience.

Our heat pumps are supported by our industry leading customer service and warranty team which is based in the UK and is open 364-days a year, providing customer service and technical support.

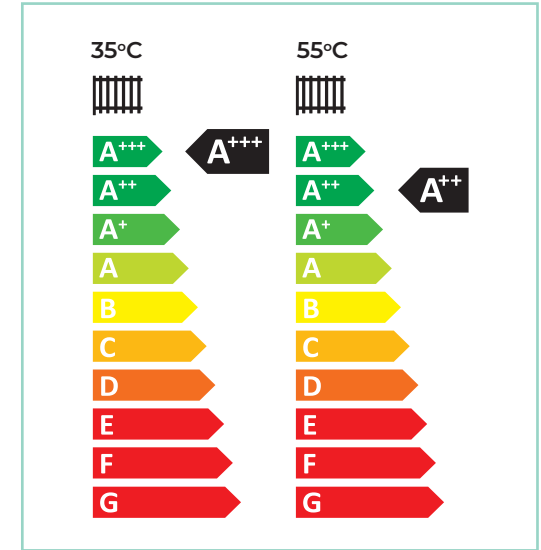

DIMENSIONS

All Dimensions in mm

	4.5kW & 6kW	8kW - 14kW
A	717	865
B	1299	1385
C	426	523
D	375	456
E	121	192
F	644	656
G	379	363
H	71	68
I	161	145
J	91	100
K	91	129

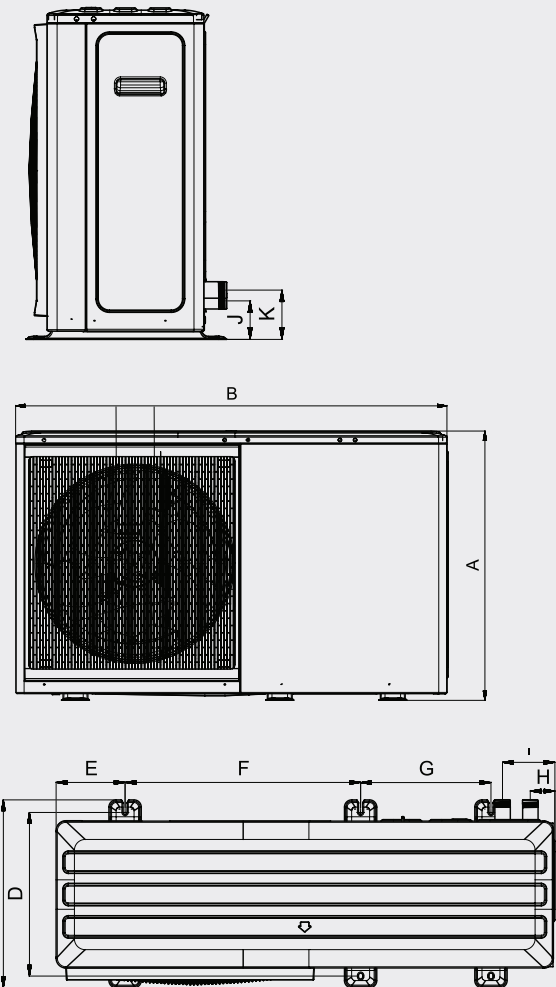

*Performance data in accordance with EN 14825 : 2016, EN 12102, EN 14511 : 2018. The energy efficiency provided may not correspond to the actual energy once installed in a building, as the efficiency is influenced by other factors such as heat loss in the distribution system and the capacity of the products in relation to building size and characteristics.

THE TECHNOLOGY

HEAT PUMP CYCLE

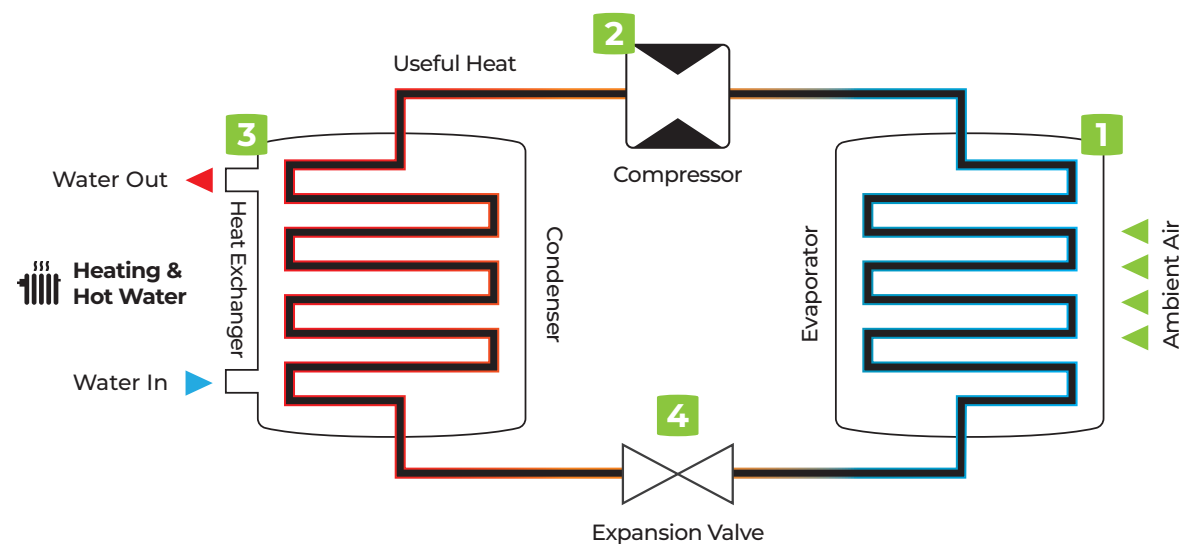

1. CAPTURE

The fan passes ambient air over extremely cold liquid refrigerant. The refrigerant captures the heat from the ambient air and becomes a warm vapour.

3. EXCHANGE

The heat in the hot refrigerant is then transferred to the heating and hot water cylinder through a heat exchanger.

2. COMPRESS

The warm refrigerant vapour passes through a compressor which produces hot refrigerant and usable heat.

4. EXPAND

Once the heat has been transferred to the house, the refrigerant passes through an expansion valve which reduces its temperature, making it really cold again and enabling it to capture heat from the ambient air, continuing the cycle.

COP & SCOP MEASUREMENTS OF EFFICIENCY

COP

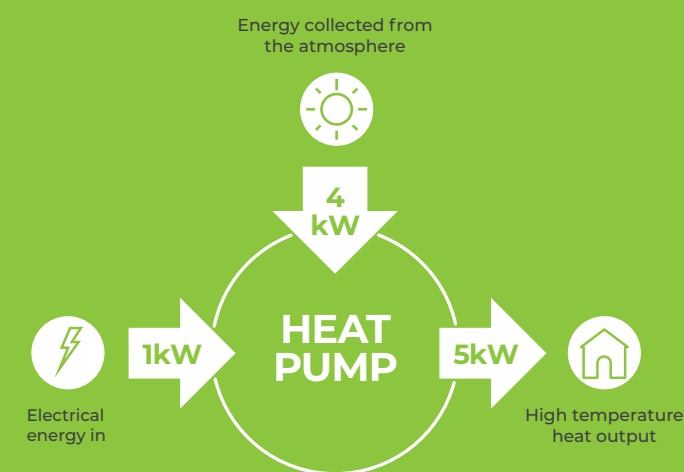

COP - COEFFICIENT OF PERFORMANCE

The coefficient of performance (COP) helps us measure the efficiency of a heat pump. The COP calculates the amount of heat energy a heat pump can create from each unit of electricity it uses.

$$\text{COP} = \frac{\text{HEAT OUTPUT}}{\text{ELECTRICAL INPUT}}$$

SCOP

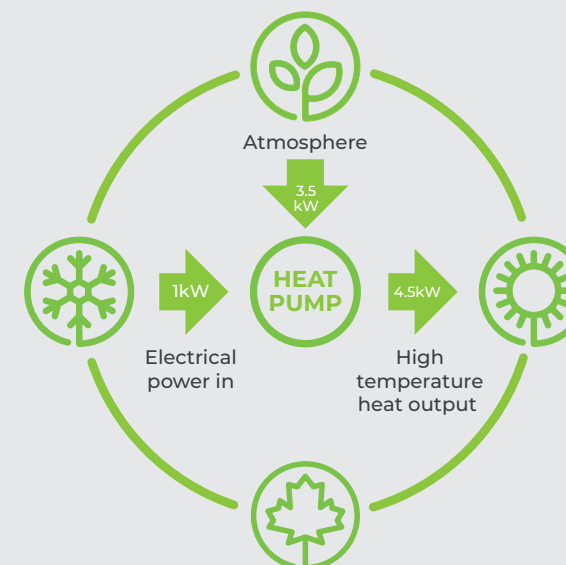

SCOP - SEASONAL COEFFICIENT OF PERFORMANCE

The seasonal coefficient of performance (SCOP) is the average COP carried over the annual heating season (the full year).

LOGIC AIR AND HP290

PRE-PLUMBED CYLINDER



Scan me for full technical specification

Our stainless steel pre-plumbed hot water cylinders combine efficiency with practicality. Designed and manufactured in the UK and boasting industry leading reheat times, our cylinders have been designed to store and generate hot water efficiently using a heat pump.



DESIGNED TO FIT IN UK HOMES

KEY FEATURES

- ✓ Up to 70°C hot water
- ✓ 28.5% energy savings*
- ✓ Built in low loss header or buffer tank
- ✓ 49% faster reheat times*
- ✓ Fully pre-plumbed and pre-wired



The Logic Air pre-plumbed cylinder range comes in **16 variants** from **single zone** 150 Litre to **two zone** 300 Litre

NEW COMBINED DHW AND BUFFER CYLINDERS

The new pre-plumbed cylinder range includes models with an integrated buffer. Housing the DHW cylinder and separate buffer tank in the same case, alongside pre-wired circulation pumps and all the standard pre-plumbing components.

NEW LOW LOSS HEADER

Our new pre-plumbed low loss header cylinders de-couple the heating system from the heat pump protecting flow rates and enabling two zone control.

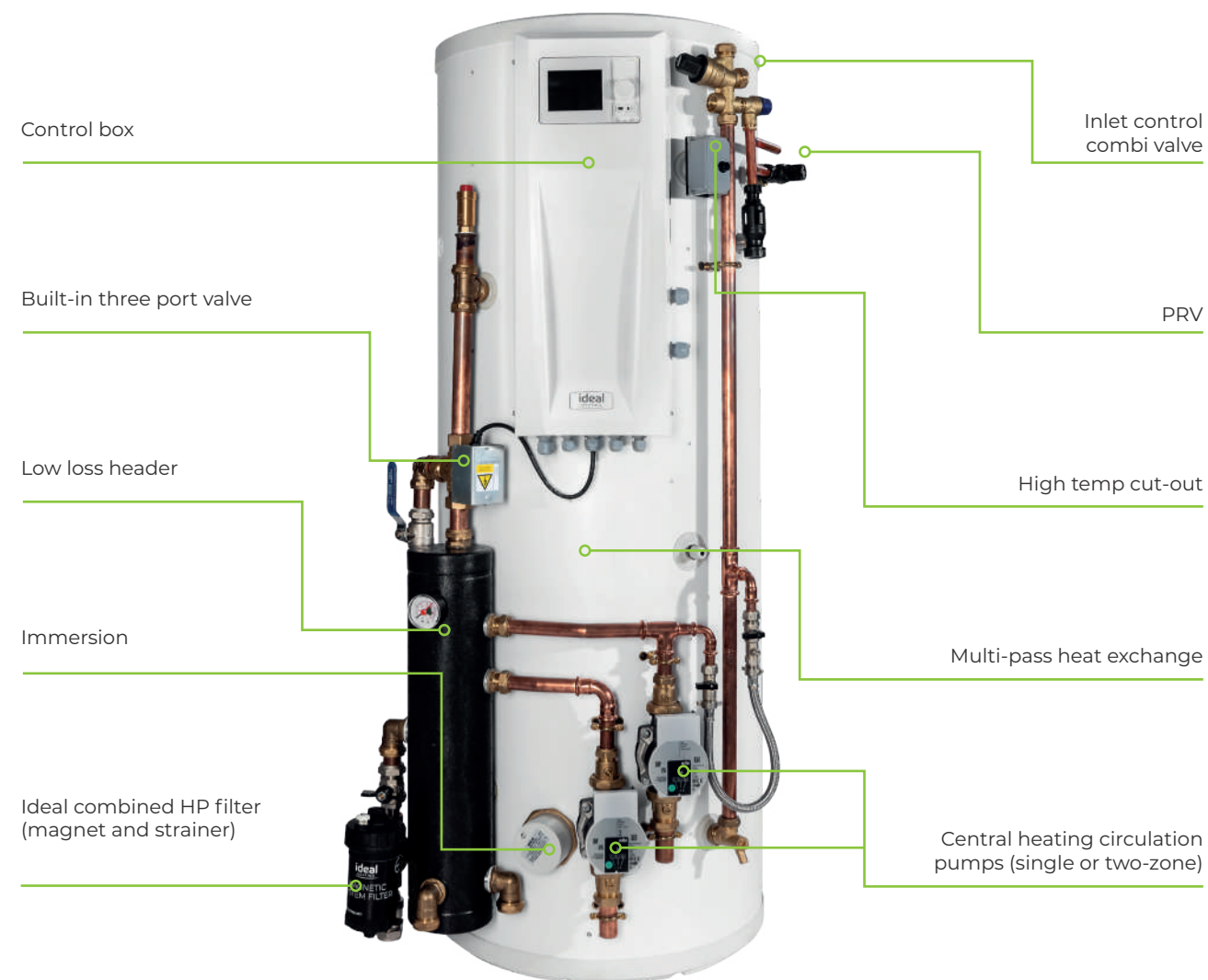

*Performance figures from for HWA 002:2020 heat pump test results

LOGIC AIR AND HP290

SINGLE ZONE PRE-PLUMBED CYLINDER



Scan me for full technical specification

The single zone pre-plumbed cylinder range offer super fast reheat times thanks to the highly efficient multi-coil heat exchanger. They are also really easy to install since they come pre-plumbed and pre-wired ready for installation with the Logic Air or HP290 heat pump.



INDUSTRY LEADING REHEAT TIMES

KEY FEATURES

- ✓ Fully pre-plumbed and pre-wired
- ✓ Control box included
- ✓ 25 year warranty*
- ✓ UK dimensions: standard & slimline
- ✓ Highly efficient multi-coil heat exchanger



LOGIC AIR AND HP290

TWO ZONE PRE-PLUMBED CYLINDER



Scan me for full technical specification

The two zone pre-plumbed cylinders include a lowloss header pre-plumbed onto the cylinder, decoupling the heating system from the heat pump, ensuring optimal flow and two zone control.



DESIGNED TO FIT IN UK HOMES

KEY FEATURES

- ✓ Fully pre-plumbed and pre-wired
- ✓ Control box included
- ✓ 25 year warranty*
- ✓ UK dimensions: standard & slimline
- ✓ Highly efficient multi-coil heat exchanger

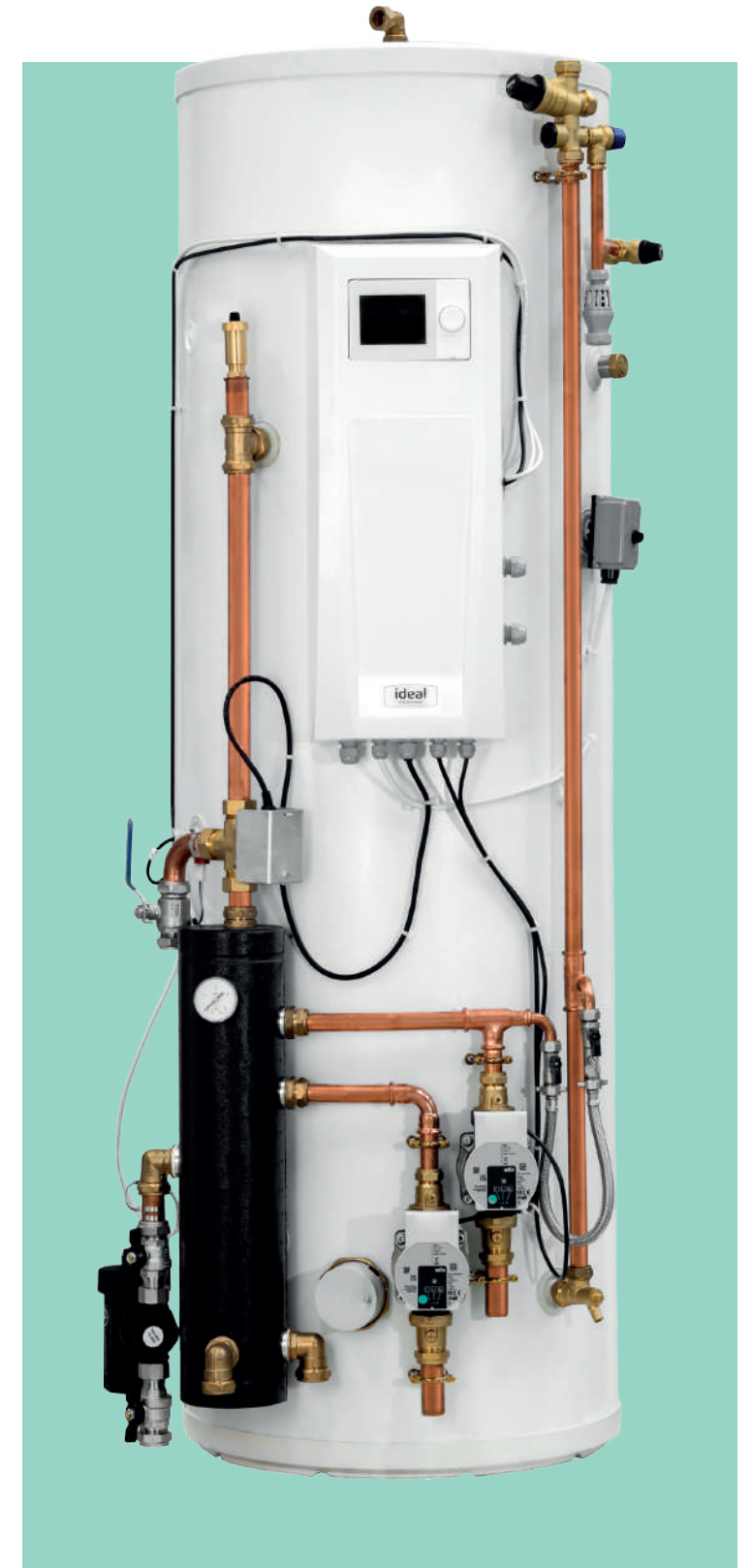

LOGIC AIR AND HP290

PRE-PLUMBED CYLINDER WITH INTEGRATED BUFFER



Scan me for
full technical
specification

The pre-plumbed cylinder range includes models with an integrated buffer. Housing the DHW cylinder and separate buffer tank in the same case, alongside pre-wired circulation pumps and all the standard pre-plumbing components.

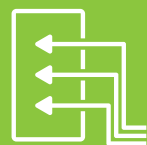

INTEGRATED BUFFER

KEY FEATURES

- ✓ Fully pre-plumbed and pre-wired
- ✓ Control box included
- ✓ Integrated buffer
- ✓ Includes circulation pumps
- ✓ Highly efficient multi-coil heat exchanger

AVAILABLE IN SINGLE
ZONE AND TWO ZONE



HALO AIR

ROOM THERMOSTAT



Scan me for full technical specification

Halo Air is a programmable room thermostat, based on the current Ideal Halo platform that is designed and developed to work seamlessly with the Logic Air monobloc heat pump.

KEY FEATURES

- ✓ Designed for Logic Air
- ✓ Easy to install
- ✓ Full heating and hot water control
- ✓ Load compensating control



COMPATIBLE WITH LOGIC AIR

HALO AIR RF 234819



Halo Air RF is a wireless programmable room thermostat designed specifically to work with Logic Air.

Halo Air offers fast, flexible and intelligent wireless technology and is packed with features that enable simple and easy heating and hot water control.

*Two year parts and labour warranty available when registered within 30 days of installation. Terms and conditions apply.

HALO AIR WI-FI 234790



Halo Air Wi-Fi is engineered specifically to work with Logic Air heat pumps and allows flexible control of heating and hot water with the intuitive Halo app, which can be connected through smart home devices like Amazon Alexa and Google Home.

It's simple to install, straightforward for everyone to use, no matter where they are.

*Two year parts and labour warranty available when registered within 30 days of installation. Terms and conditions apply.

HALO AIR 2-ZONE RF 234791



Halo Air 2-Zone RF incorporates an additional programmable room thermostat with the extra functionality of controlling the temperature of a second zone.

*Two year parts and labour warranty available when registered within 30 days of installation. Terms and conditions apply.

HALO AIR 2-ZONE WI-FI 234792



Halo Air 2-Zone Wi-Fi incorporates an additional programmable room thermostat with the extra functionality of controlling the temperature of a second zone.

*Two year parts and labour warranty available when registered within 30 days of installation. Terms and conditions apply.

LOGIC AIR

CONTROL BOX

235797

The Logic Air control box is the central hub for the heat pump system, linking the heat pump to your heating and hot water cylinder. It enables in depth control, scheduling, connectivity and performance diagnostics.

INBUILT HEAT PUMP CONTROLLER

Our inbuilt controller uses tried and tested technology to keep you warm efficiently. From scheduling to diagnostics our controller gives you control and transparency.

QUICK START SET UP

Our new quick start menu makes commissioning fast, easy and accurate. In just a few steps the heat pump can be up and running and tuned to its most efficient parameters.

CONNECTIVITY

The Logic Air control box is compatible with Halo Air, Link Cellular heat pump diagnostics and 3rd party thermostats, giving you access to online control, scheduling and remote diagnostics from anywhere in the world.



SMART GRID COMPATIBLE / SOLAR PV COMPATIBLE

The Logic Air control box is smart grid ready and can connect to solar PV, enabling smarter ways of powering heating and hot water.

PERFORMANCE DIAGNOSTICS

The Logic Air control box gives you access to the efficiency of the householders heating system, helping them to understand the health of their heat pump system at a glance.

HP290

CONTROL BOX

239386

The HP290 control box is a hub for a HP290 heat pump system. By bringing all electrical connections to one central location, the HP290 control box enables a fast and simple installation experience.

The HP290 Control Box incorporates the HP290 Controller into a central indoor wiring centre complete with all electrical components providing a quick and simple installation process utilising one cable between the control box and HP290 monobloc heat pump.



HP290

CONTROLLER

241519

The HP290 controller offers a budget friendly and flexible option for those not looking to purchase the HP290 Control Box.

The HP290 controller provides the controls and user interface for the HP290 heat pump without the electrical ancillaries, indoor wiring centre or control box.

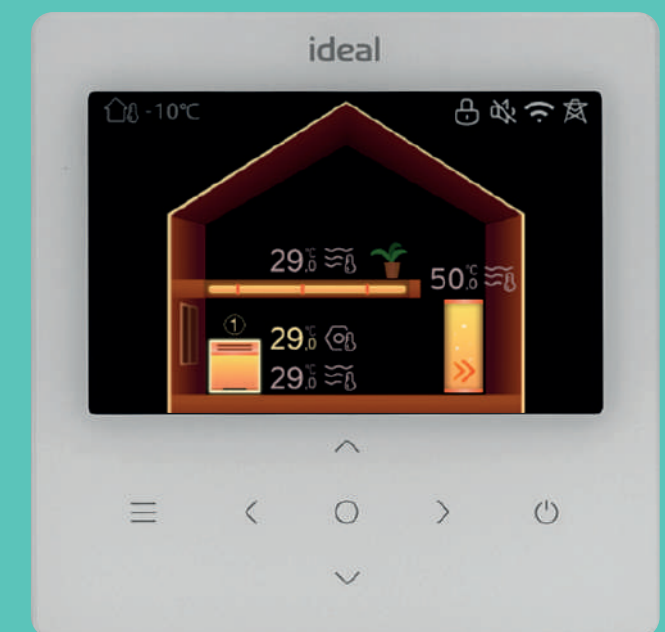

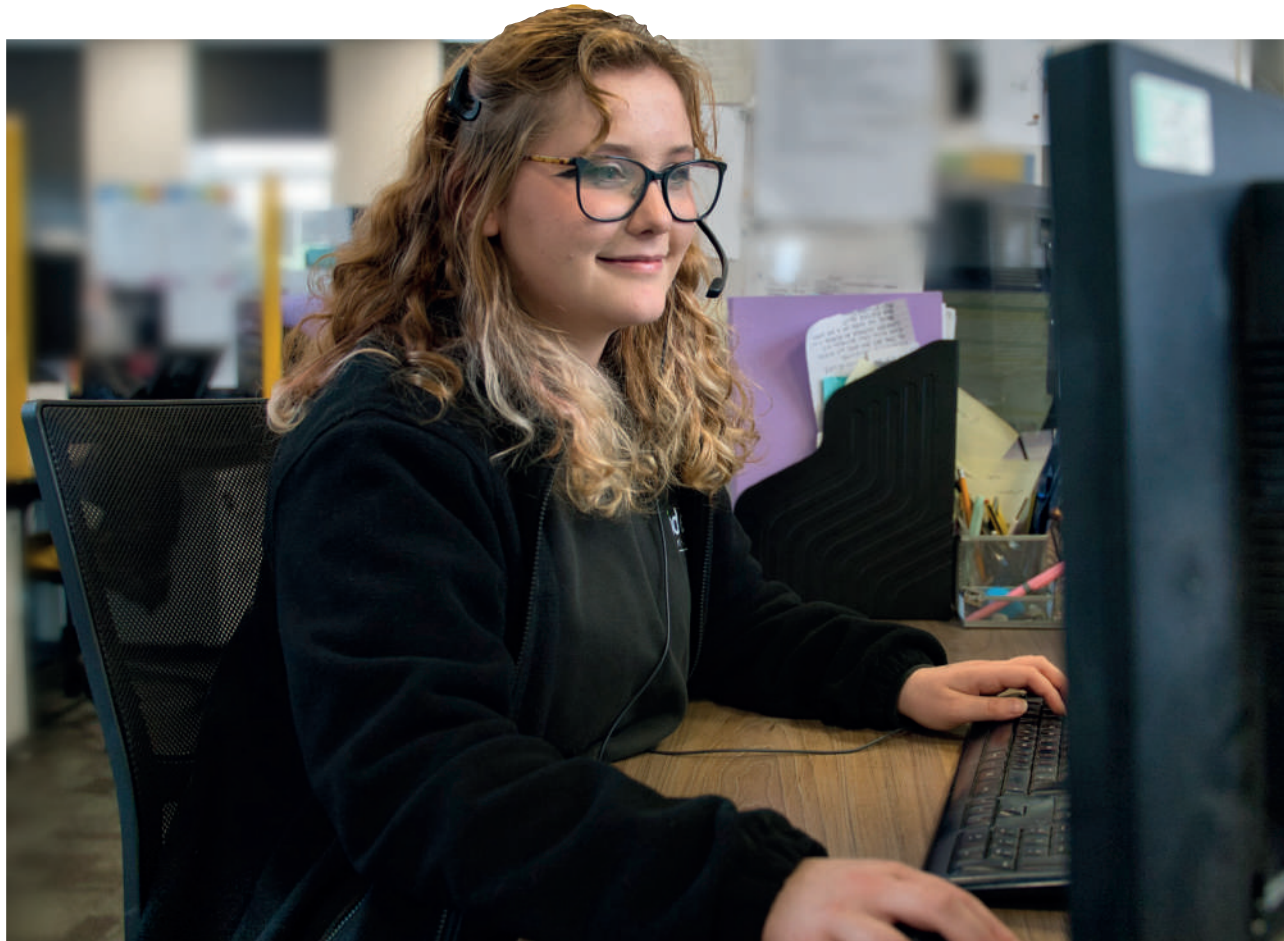

INDUSTRY LEADING CUSTOMER SERVICE



EXPERTS TOGETHER

We are committed to delivering the highest level of customer service. Experts together with over 140 years experience of heating and hot water, we know how important confidence and trust are to our customers.



364 DAYS A YEAR

We are is on hand to ensure you have the support you need. Our dedicated customer service department is available 364 days a year.



TEAM OF EXPERTS

We also have a team of expert engineers, fully trained to exacting standards and Gas Safe registered, on hand to provide one-to-one advice on the road, over the phone or online ensuring you're fully supported, wherever and whenever you need.

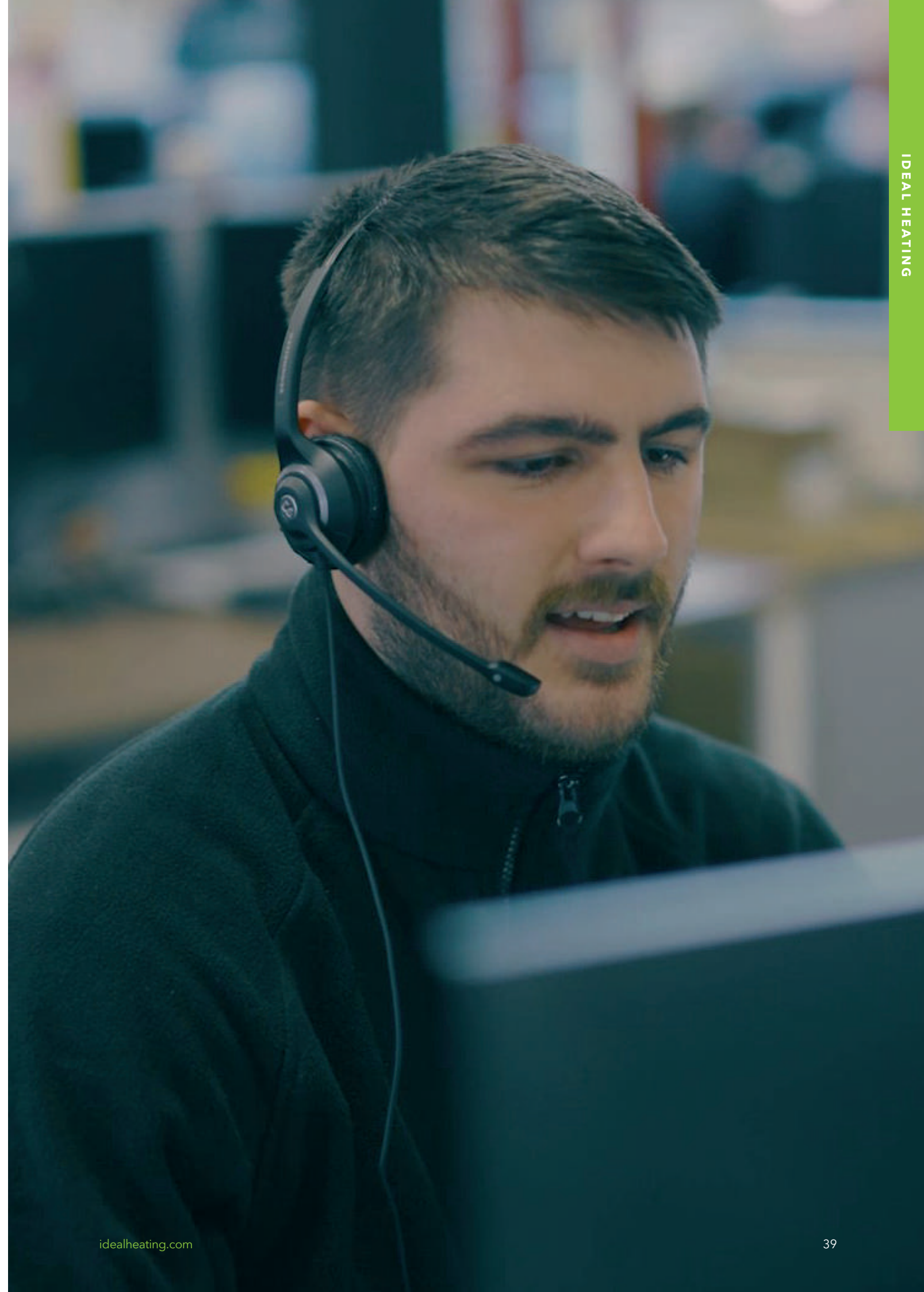

NOTES



Customer Service:

01482 498660

Technical Help:

01482 498663

Ideal Heating, PO Box 103, National Avenue,
Kingston upon Hull, East Yorkshire, HU5 4JN

enquiries@idealheating.com



idealheating.com

The information in this brochure was correct at the time of going to print. Ideal Heating reserve the right to make any modifications to product specifications or any other details, without prior notification. For further clarification, please enquire in writing to the head office address above.