



# LINK DIAGNOSTICS INSTALLATION GUIDE

## HEAT PUMP

For the very latest copy of literature for specification and maintenance practices visit our website [idealheating.com](https://www.idealheating.com) where you can download the relevant information in PDF format.

May 2024

UIN 235851 A06





The code of practice for the installation, commissioning  
& servicing of central heating systems

## CONTENTS

1.0	KIT CONTENTS .....	3
2.0	WELCOME.....	4
3.0	OVERVIEW .....	5
4.0	INSTALLING THE BRACKET .....	6
5.0	INSTALLING THE LINK DIAGNOSTIC UNIT.....	9
6.0	LED KEY & TROUBLESHOOTING CELLULAR CONNECTIVITY.....	11
7.0	LED KEY & TROUBLESHOOTING WI-FI CONNECTIVITY.....	12
8.0	TECHNICAL SPECIFICATIONS.....	13
9.0	WARRANTY .....	14

## 1.0 KIT CONTENTS

### a. Link Diagnostics Device

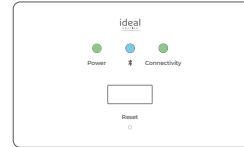

### b. Install Guide

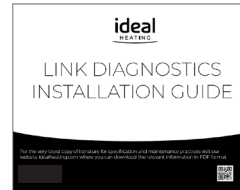

### c. Wall Bracket

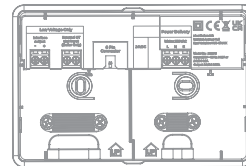

## 2.0 WELCOME

---

This guide is applicable to the following products; 235545, 235473, 235378, 234793, 235276 & 235378.

To begin scan the QR to download the Link Pro app. You can use your Connect login details.

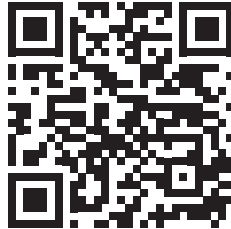

This module will connect, via the Link Pro app, through a 2G cellular, NB-IoT or Wi-Fi connection, to the secure Ideal Heating Cloud.

Once connected to the Ideal Heating Cloud this module will communicate diagnostic and telemetry heat pump data to Ideal Heating and the housing provider to assist with service, maintenance, and fault diagnosis.

POWER LED

BLUETOOTH LED

CONNECTIVITY LED

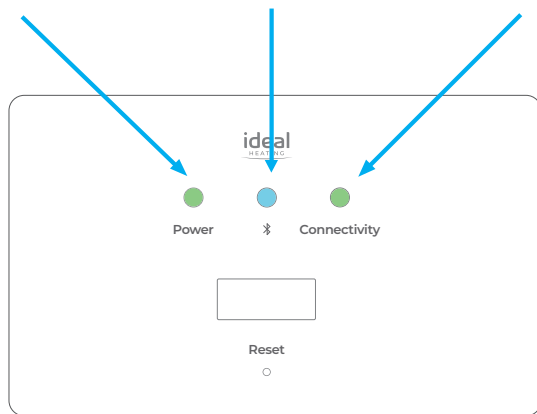

## 4.0 INSTALLING THE BRACKET

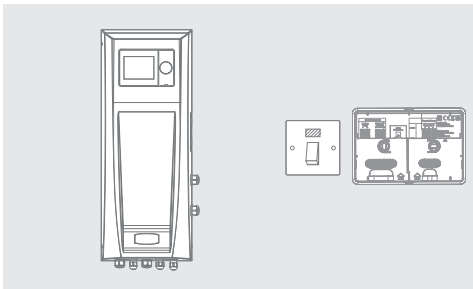

1. Locate the bracket in a suitable location close to the heat pump control box and a fuse spur as the bracket is hard wired to both.

**Note: For Wi-Fi diagnostics, the bracket should be <30m from the Wi-Fi router otherwise a Wi-Fi extender may be required.**

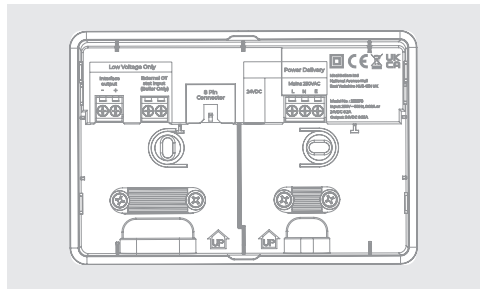

- 2a. To mount directly onto the wall, mark and drill 2 mounting holes and fix the bracket to the wall using suitable fixings for the wall type.

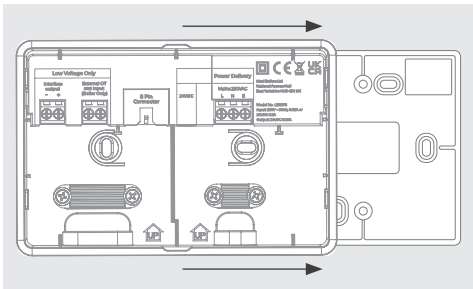

- 2b. To mount over the electrical box, place the bracket over the electrical box and fix into place.

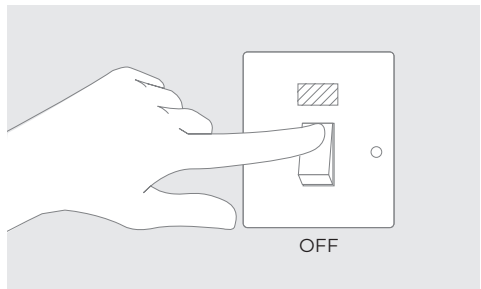

3. Isolate the mains supply to both heat pump control box and fuse spur for the bracket.

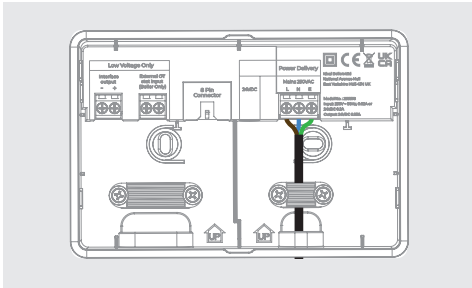

4. From the fuse spur wire the Live, Neutral and Earth connections into the right hand side connections in the Bracket marked L, N, E.

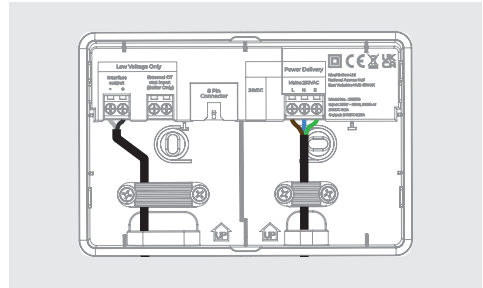

5. Wire the low voltage connection into the BSB terminals located on the left hand side. Rear or surface mount options are available.

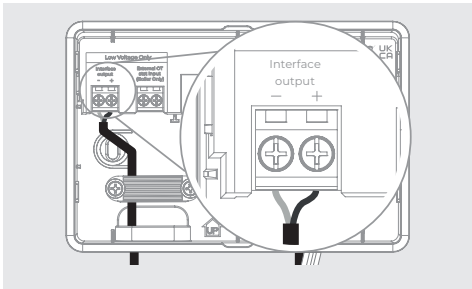

- 5a. BSB is polarity conscious. Ensure that + and - connections are wired to the same terminal in the heat pump. + to + and - to -.

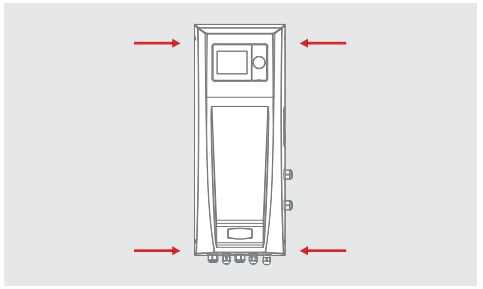

6. Ensuring Mains supply is still isolated, remove the 4 screws retaining the control box cover before removing the cover.

## 4.0 INSTALLING THE BRACKET - CONT'D

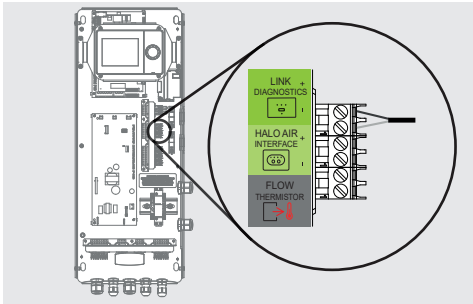

7. Wire the BSB connection from the bracket into the Link Diagnostics terminals making sure the polarity is correct, and cable retention is in place

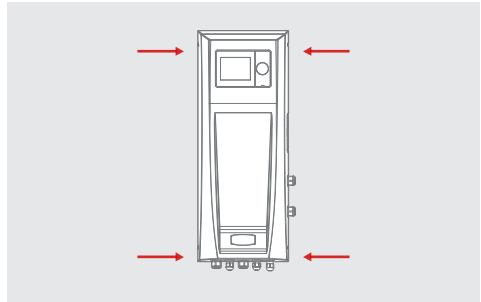

8. Install the cover and screws.



## 5.0 INSTALLING THE LINK DIAGNOSTIC UNIT

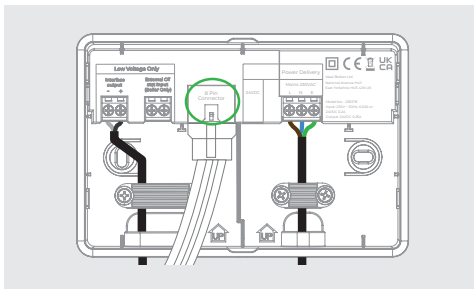

1. Install the Link Diagnostics module by connecting the plug on the Link device to the connector in the bracket.

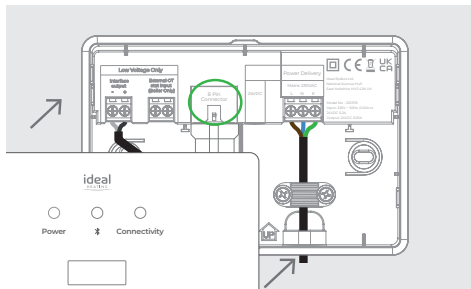

2. Push the Link Diagnostics module into the bracket.

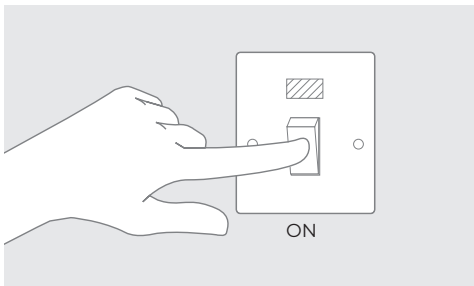

3. Re-establish power to both the heat pump and the Link module. The Link module will power up and begin set up.

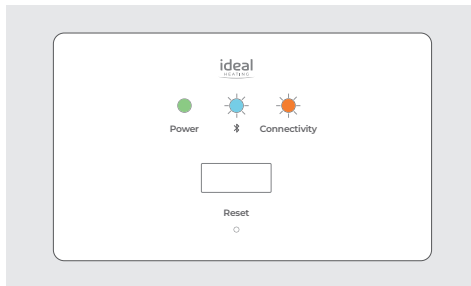

4. Once the Power LED is solid Green, the unit will automatically activate Bluetooth provisioning mode for 15 minutes and the Bluetooth LED will flash Blue. If the Bluetooth LED is not illuminated then please press and hold the pairing button, until the Bluetooth LED begins to flash Blue again.

**Please note, the connectivity LED will flash Orange until a connection is established, this will then turn solid Green if successful.**



5. Launch the Link Pro app on your smart device and follow the in-app instructions.

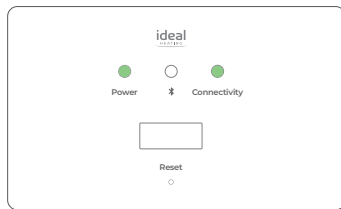

6. Once successful cloud connection is achieved, the connectivity LED will turn solid **Green**.

**The Bluetooth LED will remain on until the device is connected via the app. It can also turn off fifteen minutes after startup.**

## 6.0 LED KEY & TROUBLESHOOTING CELLULAR CONNECTIVITY

---

<b>LED</b>	<b>STATUS</b>
Power	Green - Power ON No illumination - No power
Bluetooth	Blue (flashing) - Bluetooth/cellular pairing mode active Blue - Bluetooth connection to smart device active
Connectivity	Orange (flashing) - Searching/identifying cellular network Blue - Successful connection to cellular network Green - Successful connection to the cloud Red - Failed to connect to cellular network Red (flashing) - No sim/sim card error
Bluetooth pairing times out	Press and hold the pairing button for 5 seconds to re-enter Bluetooth pairing mode
Factory reset of the link cellular	Press and hold the pairing button for 15 seconds - all LEDs will extinguish and the unit will reboot

## 7.0 LED KEY & TROUBLESHOOTING WI-FI CONNECTIVITY

---

<b>LED</b>	<b>STATUS</b>
Power	Green - Power ON No illumination - No power
Bluetooth	Blue (flashing) - Bluetooth/Wi-Fi pairing mode active Blue - Bluetooth connection to smart device active
Connectivity	Orange (flashing) - Searching/identifying Wi-Fi network Blue - Successful connection to Wi-Fi network Green - Successful connection to the cloud Red - Failed to connect to Wi-Fi network
Bluetooth pairing times out	Press and hold the pairing button for 5 seconds until the Bluetooth LED flashes blue
Factory reset of the Link Wi-Fi	Press and hold the pairing button for 15 seconds - all LEDs will extinguish and the unit will reboot

## 8.0 TECHNICAL SPECIFICATIONS

---

Supply voltage or voltage range:	24 VDC
Power or current rating:	200 mA
Indoor or outdoor use:	Indoor use
Altitude:	2000 m
Ambient operating temperature:	0 - 40° C
Relative humidity:	10 - 90% R.H., non-condensing
Pollution degree of the intended environment:	Class II

**Your Ideal Link Diagnostics comes complete with a 2-year Ideal Guarantee, subject to the following terms and conditions.**

During the period of the guarantee we will replace free of charge, where it suffers a mechanical or an electrical breakdown as a result of defective workmanship or materials, subject to the following conditions and exclusions;

1. The guarantee will commence from the date of installation. Without proof of purchase the guarantee will commence from the date of manufacture (via serial number).
2. The Installation needs to be registered within 30 days of installation, it can be registered online by visiting [idealheating.com](http://idealheating.com).
3. If the control suffers a mechanical or an electrical breakdown we should be contacted on one of the following numbers:

**Northern Ireland:**

T: 02890 331444

**Elsewhere in the UK:**

T: 01482 498660

Our normal working times, excluding Bank Holidays, are:

8am – 6pm Monday to Friday

8am – 4pm Saturday

8am – 12 noon Sunday

4. The guarantee does not apply:

- a. To any defect, damage or breakdown caused by deliberate action, accident, misuse or third party interference including modification or failed batteries.
- b. To any defect, damage or breakdown caused by the design, installation and maintenance of the central heating system.
- c. To any other costs or expenses caused by or arising as a result of the breakdown of the controls.
- d. To any defect resulting from the incorrect installation of the controls. To any costs incurred during delays in fixing reported faults.

Our Ideal Guarantee is offered in addition to the rights provided to a consumer by law. Details of these rights can be obtained from a Trading Standards Authority or a Citizens Advice Bureau.

### **Guarantor**

Ideal Boilers Ltd, P.O. Box 103, National Avenue, Hull, HU4 5JN.

### **Consumer Helpline**

T: 01482 498660



## Technical Training

Our Expert Academy offer a range of training options designed and delivered by our experts in heating. For details please visit [expert-academy.co.uk](http://expert-academy.co.uk)

Ideal Heating Ltd., pursues a policy of continuing improvement in the design and performance of its products. The right is therefore reserved to vary specification without notice.

Hereby, Ideal Boilers LTD declares that this device (Models 235545, 235473 & 235378) is in compliance with:  
Directive 2014/53/EU.

The full text of the EU declaration of conformity is available at [idealheating.com](http://idealheating.com)  
For more information and FAQs visit [.idealheating.com](http://.idealheating.com)

Ideal is a trademark of Ideal Boilers Ltd.  
Registered Office Ideal Boilers Ltd., National Avenue, Hull, East Yorkshire, HU5 4JB  
Tel 01482 492251 Fax 01482 448858  
Registration No. London 322 137

Ideal Technical Helpline: 01482 498663    Ideal Consumer Helpline: 01482 498660    Ideal Parts: 01482 498665  
[idealheating.com](http://idealheating.com)

**ideal**  
HEATING